

Artemide®

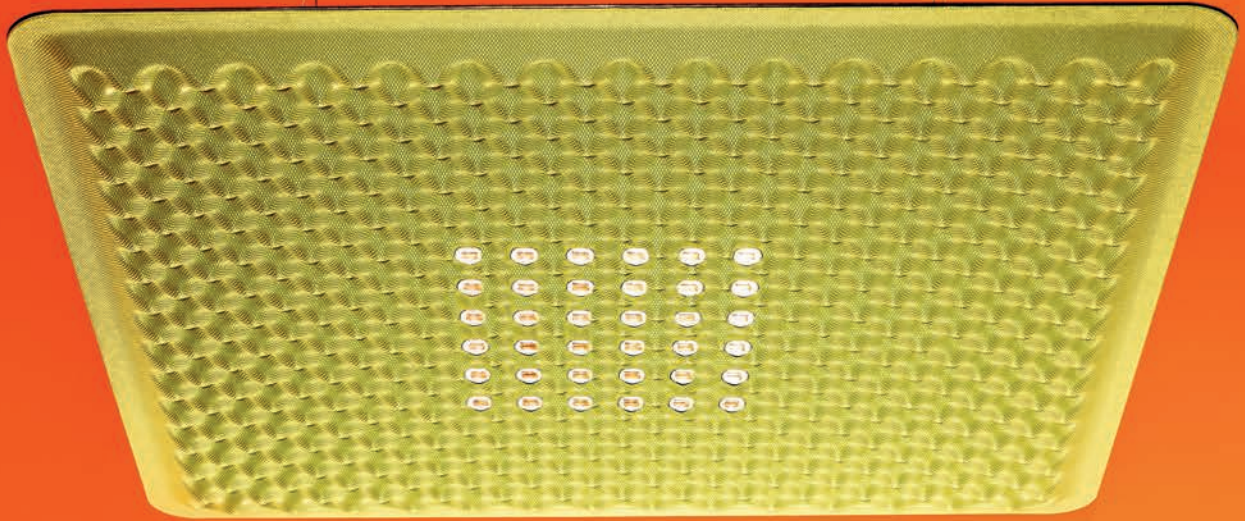

Eggboard



Eggboard

Giacobone & Roj - Progetto CMR

↪ 2014

Eggboard is a resounding innovation, offering an efficient lighting solution with sound-absorbing properties. The intelligent fabric minimizes sound reflection and echo in a space, a feature that makes a difference in open spaces, especially in workspaces. Crafted of PET, a high quality material molded into a shape inspired from cardboard egg packaging, Eggboard is available in various colors, bringing a design accent to any office or commercial space. Crafted of PET, a high quality material molded into a shape inspired from cardboard egg packaging, Eggboard is available in various colors, bringing a design accent to any office or commercial space.



Artemide
App



For further information on Eggboard ↪ visit artemide.com







Eggboard typologies



Artemide App

SUSPENSION



EGGBOARD MATRIX
1600X800



EGGBOARD ACOUSTIC
1600X800



EGGBOARD MATRIX
800X800



EGGBOARD ACOUSTIC
800X800

SUSPENSION



EGGBOARD BAFFLE
1600X400



EGGBOARD BAFFLE
800X400



EGGBOARD ACOUSTIC
1600X400
1600X800

WALL / CEILING

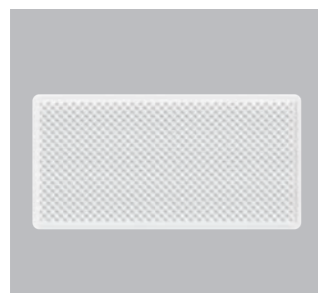

EGGBOARD 1600 X 800

Acoustic panel without light emission
(optional backlighting modules to be ordered separately)



EGGBOARD 1600 X 400

Acoustic panel without light emission
(optional backlighting modules to be ordered separately)

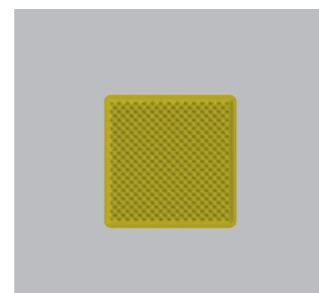

EGGBOARD 800 X 800

Acoustic panel without light emission
(optional backlighting modules to be ordered separately)

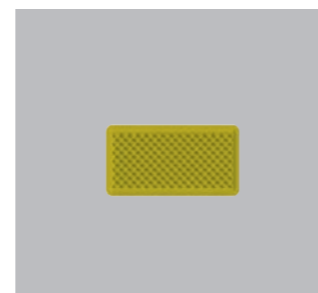

EGGBOARD 800 X 400

Acoustic panel without light emission
(optional backlighting modules to be ordered separately)

CEILING

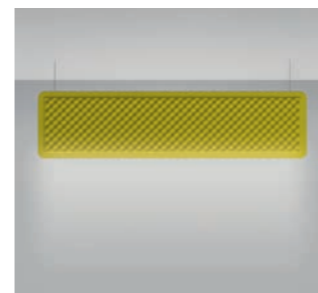

EGGBOARD BAFFLE
1600X400

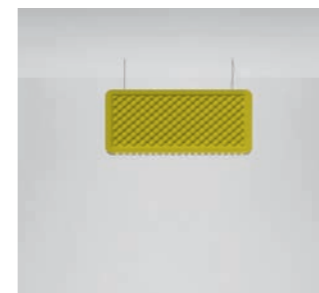

EGGBOARD BAFFLE
800X400

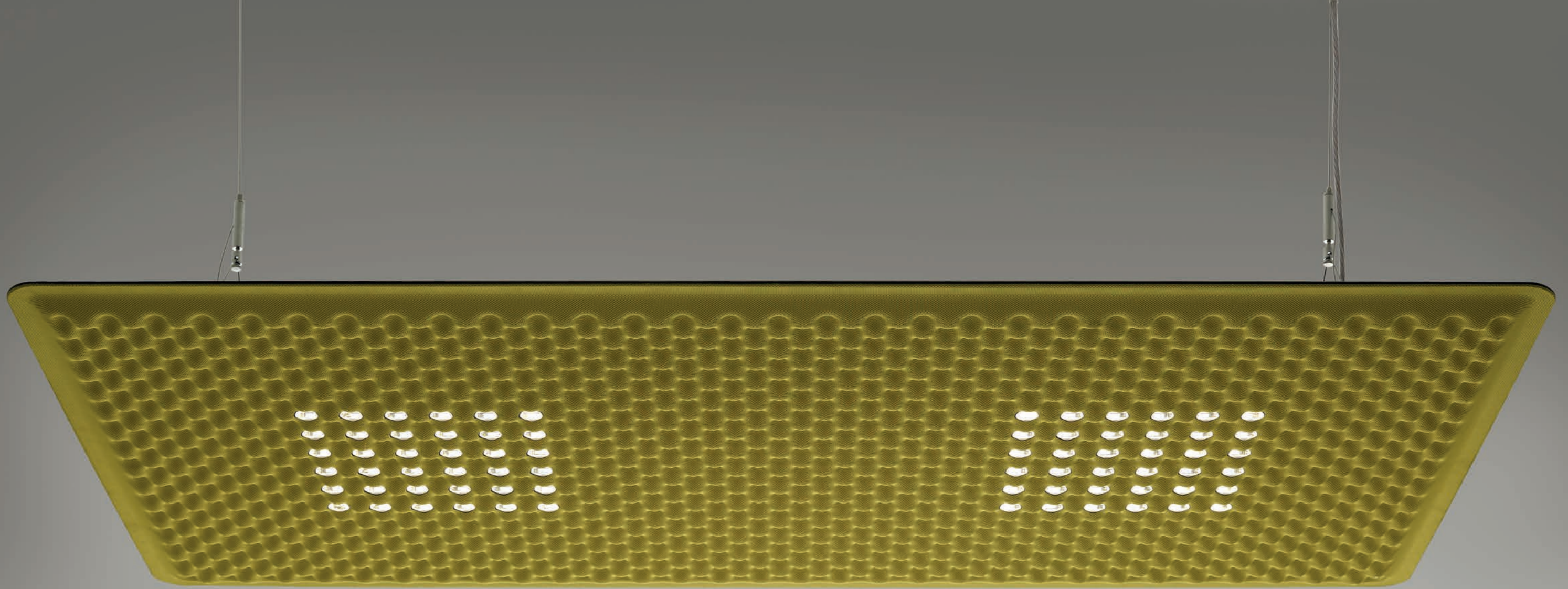

Eggboard ↪ Matrix

Suspension appliance with sound-absorbing properties ensured by an unusual sinusoidal cross-section design of the lower surface and the use of a sound-absorbing material.

Acoustic efficiency is ensured within a limited space by positioning at approximately one metre above the head of the speaker and listener.

Direct emission: a board with a high number of low-voltage LEDs ensures maximum lighting comfort.

Reflectors can be rotated for use on single or counterposed double desk.

Complies with the norms on office activities that involve the use of video-terminals (UGR<19).

Available in 3 colours (white, grey, green) and 2 different sizes (1600X800mm - 800X800mm).



↳ EGGBOARD MATRIX 1 DESK

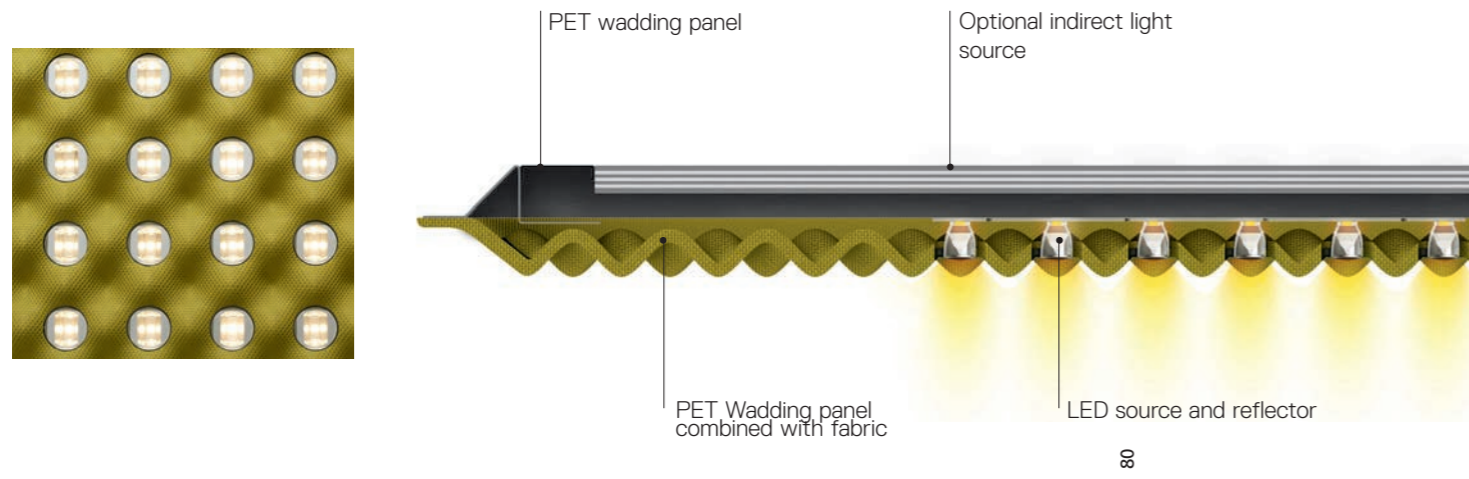

↳ EGGBOARD MATRIX 2 DESK

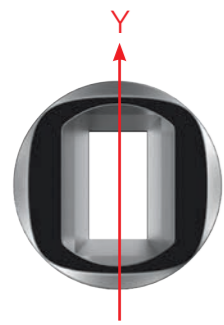
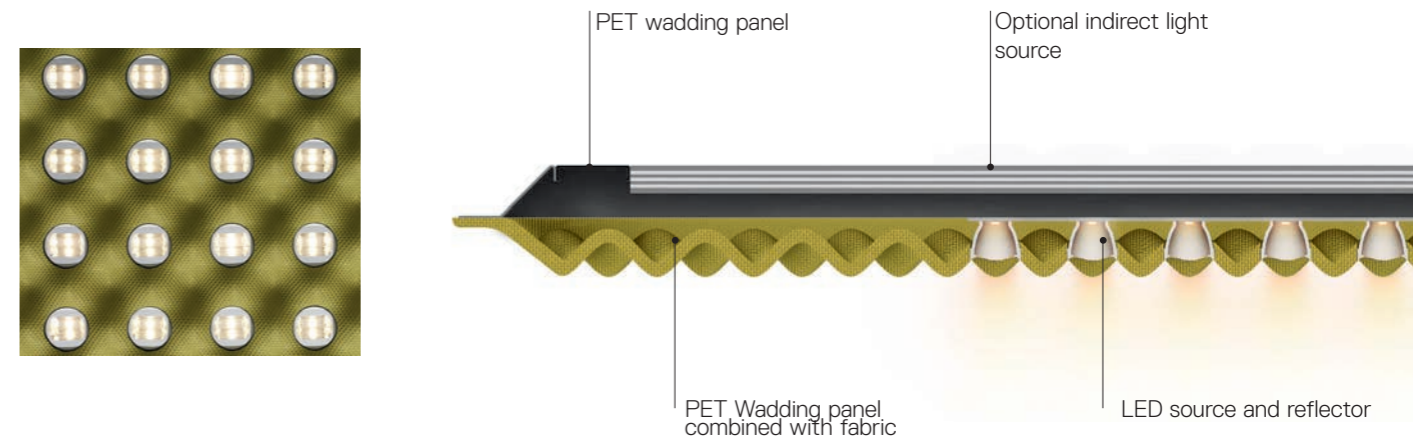

Rotating the elliptic-beam reflector along the Y axis allows to use the product to illuminate one workstation.

UGR < 12

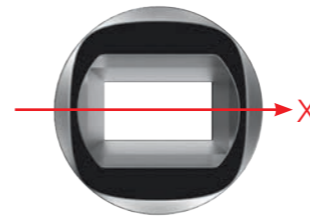
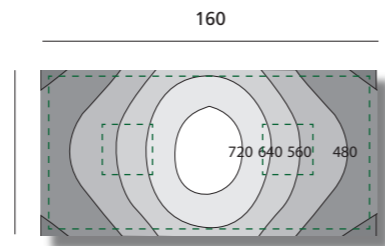

Rotating the elliptic-beam reflector along the X axis allows to use the product to illuminate two workstations.

UGR < 17

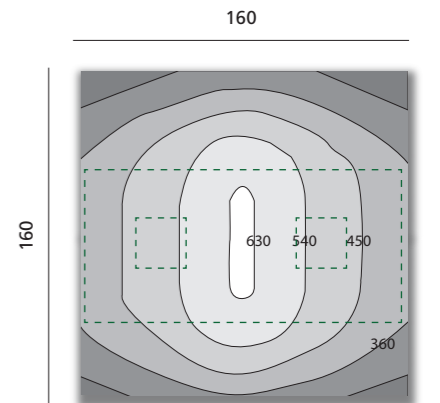



↳ EGGBOARD ACOUSTIC PANEL

The sound-absorbing material acts by reducing the reverberation time (i.e. the time required to reduce any noise inside the room by 60 db, so as to ensure that any echoes due to reflections on the walls are inaudible).

The frequency of human voice typically ranges from 1 to 4 kHz.

The use of materials capable to reduce these frequencies allows better understanding of speech and prevents the need to talk loudly to cover the background noise.

The sound-absorbing appliance should be located 400-600 mm off the ceiling to ensure optimal operation.

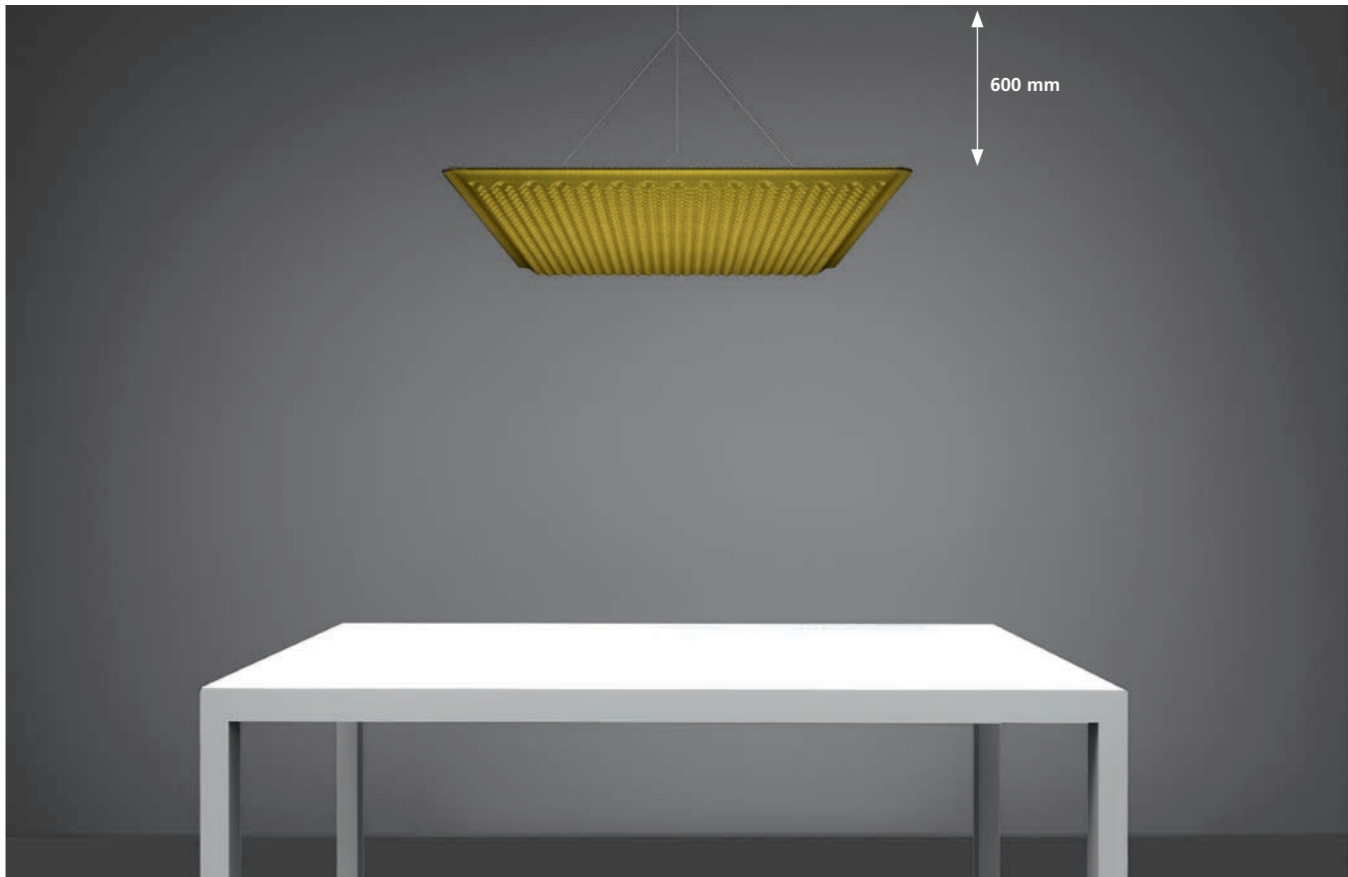
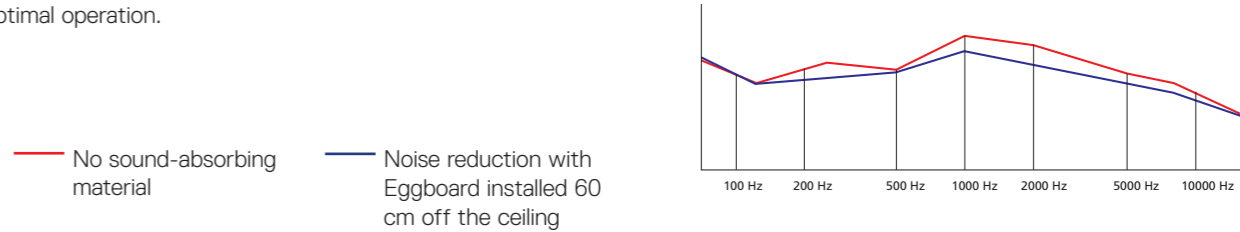

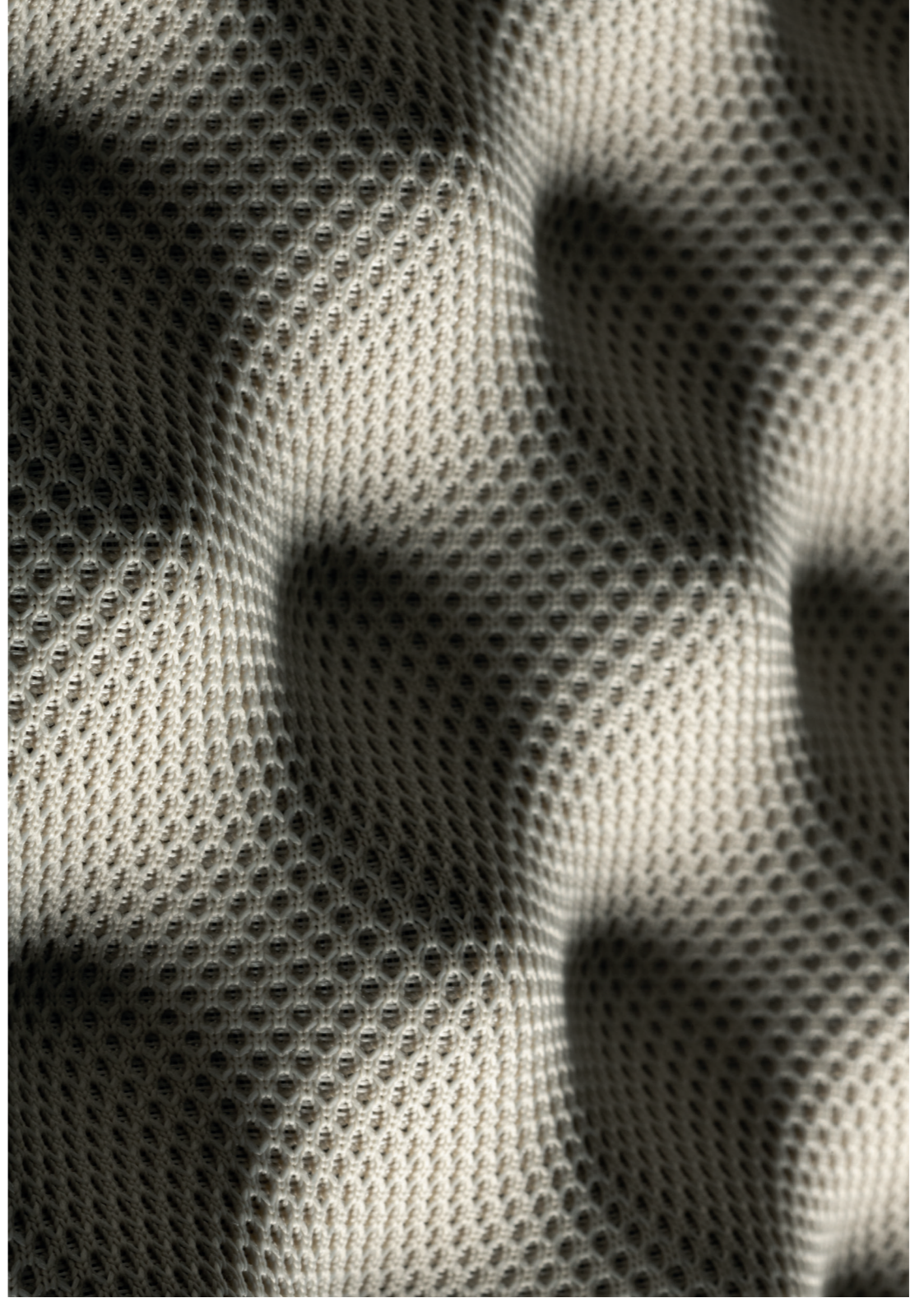
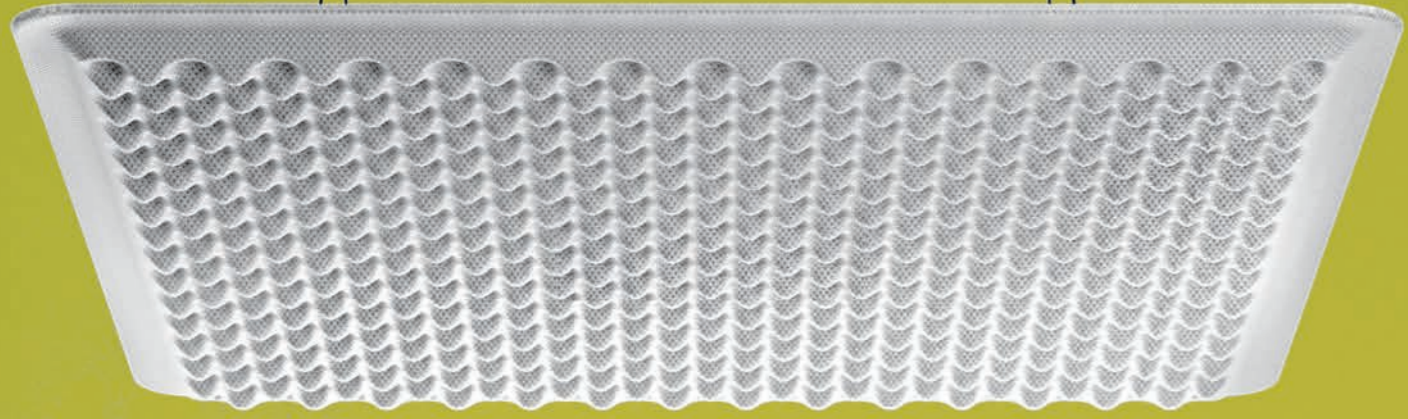

EGGBOARD MATRIX

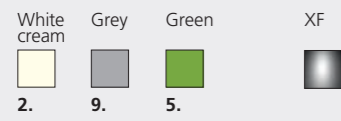

220/240Vac 50/60Hz electronic ballast included.

MacAdam 3SDCM
 Direct: Life L90 (10K)>60000h
 CRI =90
 Indirect: Life L80 (10K)>55000h
 CRI =80

IP20
 UGR<19

1600x800

Direct				
W	Weight	Beam	Flux	CCT
31 W	16,5 kg	XF	2402 lm	3000 K
			2488 lm	4000 K

Dimmable DALI	
Code	
M3100W.	2/9/5 .1
M3100N.	2/9/5 .1

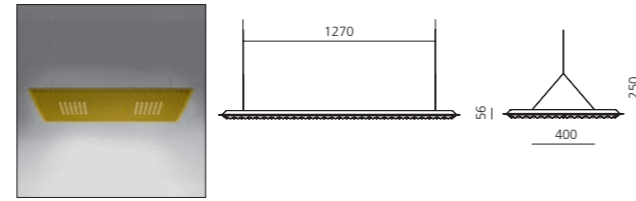

Direct + Indirect				
W	Weight	Beam	Flux	CCT
31 W	17,68 kg	XF	2402 lm direct	3000 K
			4030 lm indirect	
44 W			2488 lm direct	4000 K
indirect			4234 lm indirect	

Dimmable DALI	
Code	
M3101W.	2/9/5 .1
M3101N.	2/9/5 .1

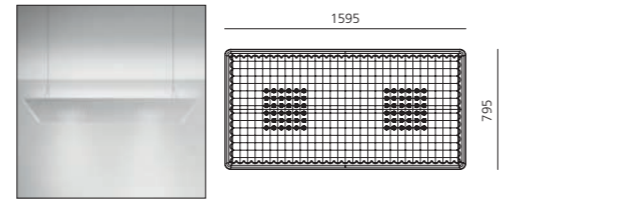

Without light	
Weight	
10 kg	

Code	
M3108.	2/9/5 .0

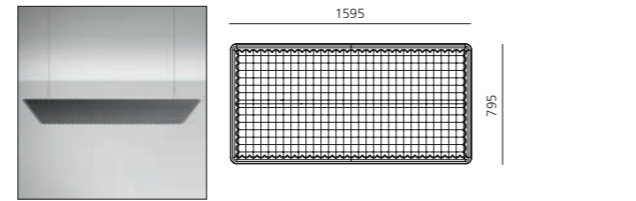

800x800

Direct				
W	Weight	Beam	Flux	CCT
16 W	9,20 kg	XF	1200 lm	3000 K
			1244 lm	4000 K

Dimmable DALI	
Code	
M3102W.	2/9/5 .1
M3102N.	2/9/5 .1

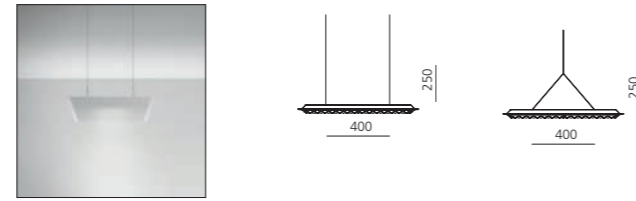

Direct + Indirect				
W	Weight	Beam	Flux	CCT
16 W direct	9,70 kg	XF	1200 lm direct	3000 K
			2015 lm indirect	
23 W indirect			1244 lm direct	4000 K
			2117 lm indirect	

Dimmable DALI	
Code	
M3103W.	2/9/5 .1
M3103N.	2/9/5 .1

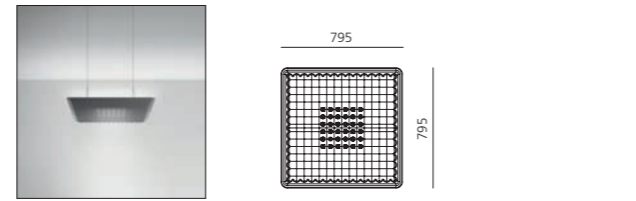

Without light	
Weight	
5 kg	

Code	
M3109.	2/9/5 .0

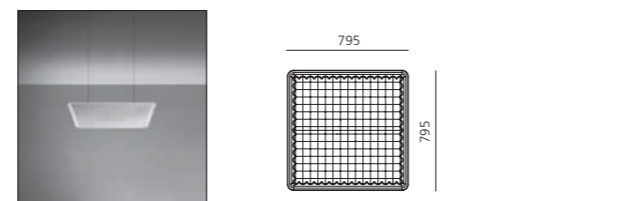





Eggboard
↪ Baffle





s2

2

1	2	3	4	5	6	7	8	9	10
Zoso	Led Zeppelin band members								Torri Garibaldi LED ZEPPELIN

MAGISTRETTI

EGGBOARD BAFFLE

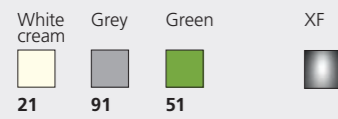

220/240Vac 50/60Hz electronic ballast included.

For the suspension version, order the ceiling rose or the APP kit separately.
For the ceiling version, order only the APP kit separately.

MacAdam 3SDCM
Direct: Life L90 (10K)>60000h
CRI =90
Indirect: Life L80 (10K)>55000h
CRI =80

IP20
⊕
UGR<19

1600x400 SUSPENSION / CEILING

Direct				
W	Emission	Beam	Flux	CCT
20 W	sharp	XF	1468 lm	3000 K
			1521 lm	4000 K

Dimmable DALI	
Code	
AZ212.	21/91/51
AZ214.	21/91/51

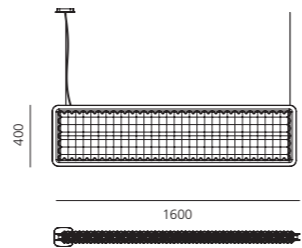

1600x400 SUSPENSION

Direct + Indirect				
W	Emission	Beam	Flux	CCT
20 W	direct sharp	XF	1468 lm direct	3000 K
41 W	indirect diffused		4927 lm indirect	
			1521 lm direct	4000 K
			5147 lm indirect	

Dimmable DALI	
Code	
AZ222.	21/91/51

AZ224. 21/91/51

800x400 SUSPENSION / CEILING

Direct				
W	Emission	Beam	Flux	CCT
9 W	sharp	XF	667 lm	3000 K
			691 lm	4000 K

Dimmable DALI	
Code	
AZ112.	21/91/51
AZ114.	21/91/51

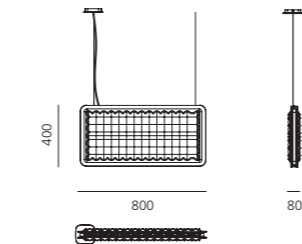

800x400 SUSPENSION

Direct + Indirect				
W	Emission	Beam	Flux	CCT
9 W	direct sharp	XF	667 lm direct	3000 K
17 W	indirect diffused		1971 lm indirect	
			691 lm direct	4000 K
			2059 lm indirect	

Dimmable DALI	
Code	
AZ122.	21/91/51

AZ124. 21/91/51

Accessories

Canopy + 1 power cable L 210, dimmable DALI only for suspension
APP power supply kit for suspension
+ 1 power cable L 210
BLL DALI interface for APP

Code	
AZ92000	
AZ92100	
AZ92200	

	Ceiling	Suspension
ND	unnecessary	-
DALI	unnecessary	AZ92000
BLL	AZ92200	AZ92100



Photograph: Olycom, Milan, ph. Andrea Martignoni, 2019

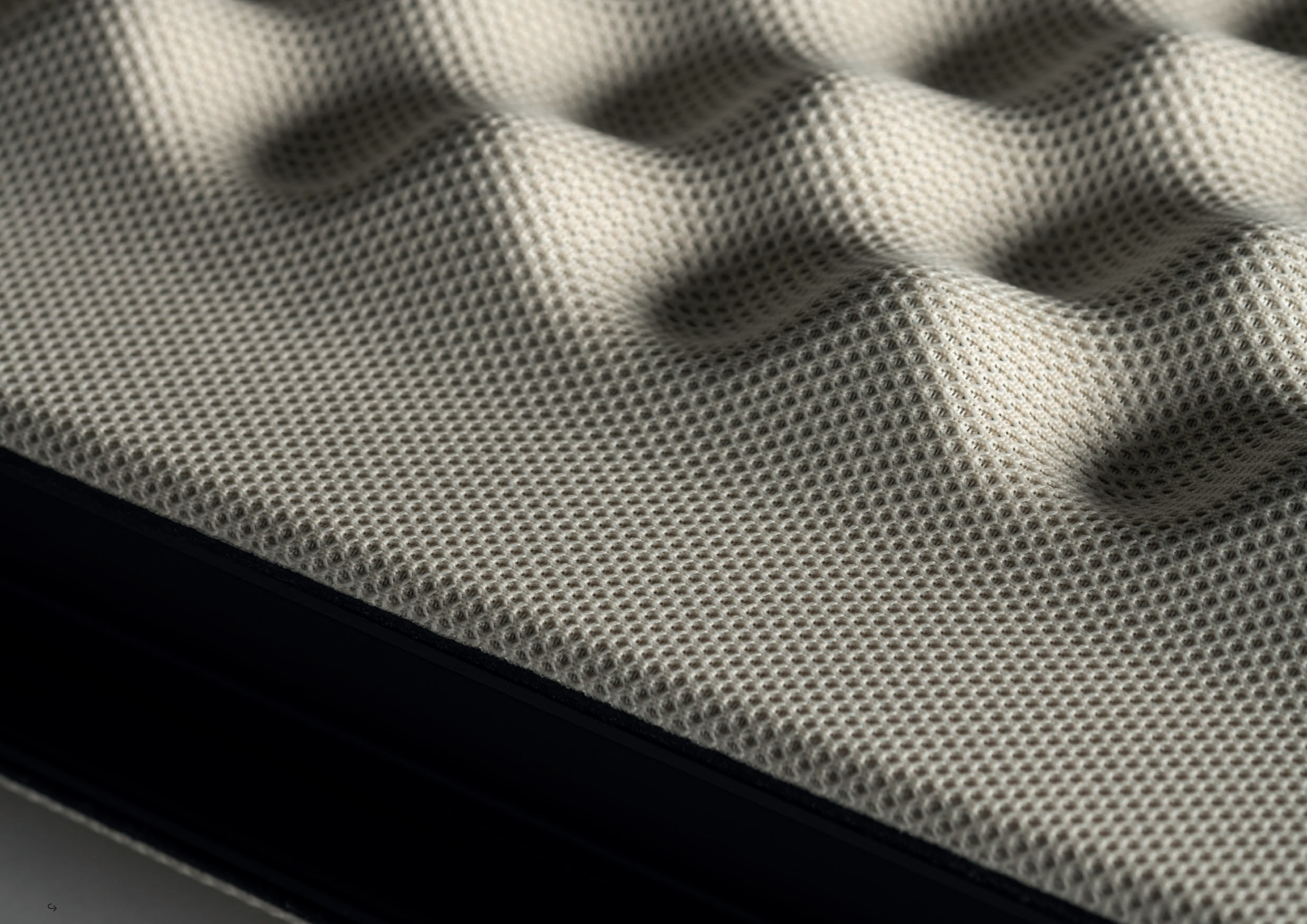

EGGBOARD ACOUSTIC PANEL / BAFFLE / BACKLIGHT

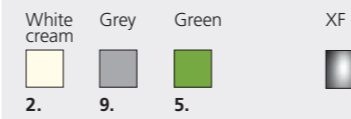

MacAdam 3SDCM
 Direct: Life L90 (10K)>60000h
 CRI =90
 Indirect: Life L80 (10K)>55000h
 CRI =80

IP20
 UGR<19

EGGOARD BAFFLE SUSPENSION / CEILING

Acoustic panel

1600 x 800
 1600 x 400

Code

AZ300. 21/91/51
 AZ200. 21/91/51

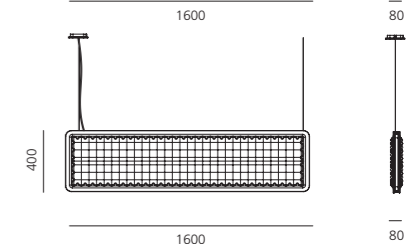
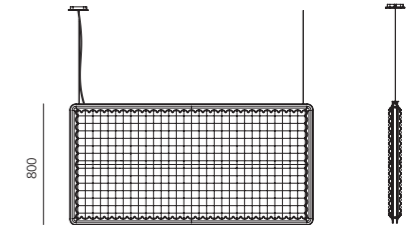
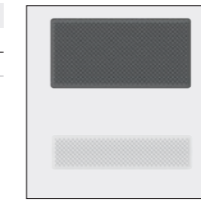

WALL - CEILING

Acoustic panel

1600 x 800
 1600 x 400
 800 x 800
 800 x 400

Code

AZ800. 21/91/51
 AZ700. 21/91/51
 AZ600. 21/91/51
 AZ500. 21/91/51

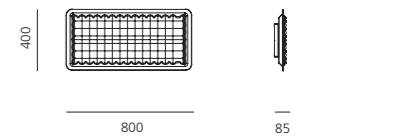
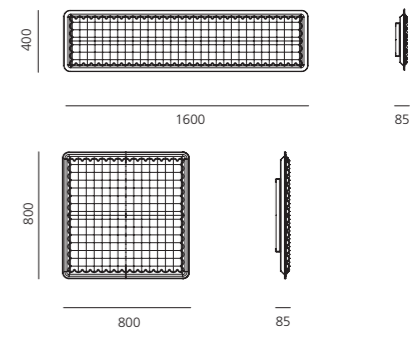
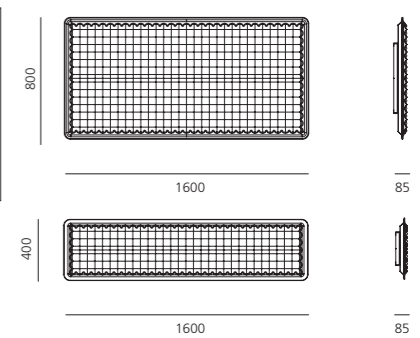
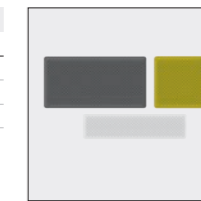

Backlight for acoustic panel

Side length	W	Beam	Flux	CCT	Code
1600	32 W	XF	3000 lm	3000 K	AZ90200
				4000 K	AZ90400
800	16 W	XF	1300 lm	3000 K	AZ90500
				4000 K	AZ90600
400	9,6 W	XF	500 lm	3000 K	AZ90700
				4000 K	AZ90800

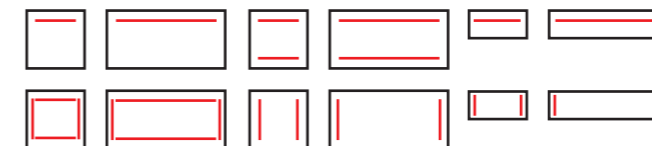

Driver	W	Vin (V)	Vout (V)	L mm	W mm	H mm	W max	Min Wire section mm ²	Max wire length m	Dimming	Code	
CV Selv	30	220-240 Vac	24Vdc	153	41	32	25	1.5	15	no	DALI 1-10V PUSH 0-10V potentiom.	DV1032
CV Selv	75	220-240 Vac	24Vdc	180	52	30	63	1.5	5	no	no	DV1009
CV Selv	120	220-240 Vac	24Vdc	300	40	30	102	1.5	3	no	no	DV1033
Dimmer	NA	24Vdc	24Vdc PWM	80	54	24	max 100	1.5	30	yes	yes	DV1048

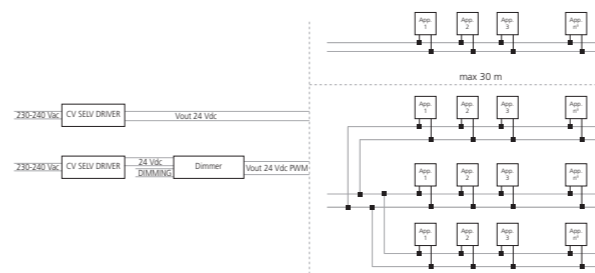

appliances number: see column W max

Eggboard Family is compatible with **Artemide App**

Artemide App is a user-friendly and intuitive interface used to control individual products, groups of appliances and lighting scenarios. It is a tool that can be associated with several products from both the Design and the Architectural Catalogues.



Download Artemide App
and find more information on
artemide.com

Headquarters

Artemide S.p.A.

Via Bergamo, 18
20010 Pregnana Milanese (MI), Italy
Tel. +39 02 93518.1
Tel. +39 02 93526.1
Numero verde 800 834 093
(from Italy only)
info@artemide.com
artemide.com

Communication and Marketing Department

Via Canova, 34
20145 Milan (MI), Italy
Tel. +39 02.349611
marketing@artemide.com
artemide.com

Artemide S.p.A.

si riserva la facoltà di modificare, in qualunque momento e senza preavviso, le caratteristiche tecniche degli elementi illustrati nel presente catalogo.

Artemide S.p.A.

reserves the right to change, at any time and without prior warning, the technical specifications of any product illustrated in this catalogue.

Artemide S.p.A.

se réserve le droit de modifier, à n'importe quel moment et sans préavis, les caractéristiques techniques des éléments illustrés dans ce catalogue.

Artemide S.p.A.

behält sich das Recht vor jederzeit und ohne Ankündigung die technischen Daten der im Katalog abgebildeten Produkte zu ändern.

Artemide S.p.A.

se reserva la facultad de modificar, en cualquier y sin aviso previo, las características técnicas de los elementos ilustrados en el presente catálogo.



ISO 9001:2015



ISO 14001:2015



ISO 45001:2018