

TORK®

ELEKTROTEKNİK

www.torkelektroteknik.com

KABLO YÜKSÜKLERİ
ISI MAKARONLARI
KABLO BAĞI
POTANSİYOMETRE
EĞER MUFLAR
TERMINALLER
BUTONLAR
KABLO UÇLARI

SKP

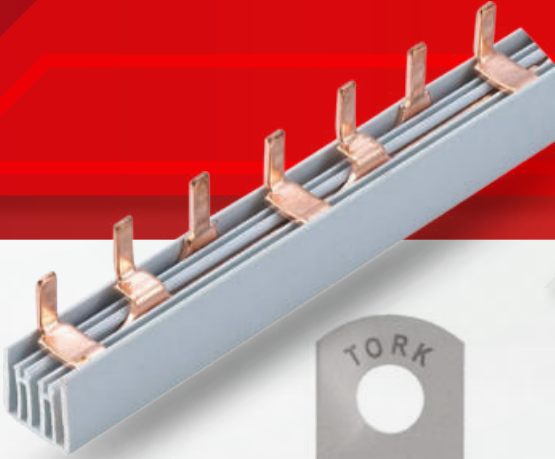

“maximum enerji maximum **TORK®**”



FİYAT LİSTESİ

ŞUBAT 2023

www.torkelektroteknik.com



tork@torkelektroteknik.com



0530 969 63 90



[torkelektroteknik](https://www.instagram.com/torkelektroteknik)

TORK®

HAKKIMIZDA

Tork Elektroteknik 2010 yılında İstanbul'da kurulmuştur. Faaliyete başladığımız ilk günden itibaren kalite ve ürün çeşitliliğini geliştirerek müşteri memnuniyeti odaklı hizmet vermek temel ilkimizdir. Şirketimizin hedefi daima Türkiye ekonomisi büyüme seviyesinin üstünde bir büyüme hedefi gerçekleştirmektir. İleriki yıllar için de aynı prensip ve hedef doğrultusunda çalışma gayretlerimizi sürdürüleceğiz.

Üretim kalemlerimiz dışında, sizlerin talepleri göz önüne alınarak ithalatını gerçekleştirdiğimiz geniş ürün yelpazemiz ile siz değerli iş ortaklarımıza hizmet vermeye devam etmekteyiz. Kalite politikamız gereği %100 Müşteri memnuniyeti ön planda olması ve güvenilir marka anlayışı ile üretim ve ithalatımıza hız kesmeden devam etmekteyiz.

Firmamız kalite politikamız gereği, uluslararası kalite standartlarında gerçekleştirdiği hizmet ve üretimi, ISO CE, TSE sertifikalarıyla belgelendirmiştir. Hedefimiz kalite standartlarını yükselterek üretim hattımızın çeşitliliğini arttırarak sektöründe zirveyi hedeflemektedir. Bu alanda uzman ekibimiz ile siz değerli müşterilerimize hakettiğiniz en iyi hizmeti ve kaliteyi sunmak bizim önceliğimiz olup, personelimiz bu doğrultuda sizlere her türlü desteği sağlamaktadır.



“maximum enerji maximum **TORK®**”

STANDART BEYAZ KABLO BAĞLARI Naylon 6.6	2	Ø 22 MM VOLTAMPERMETRE	33
STANDART SİYAH KABLO BAĞLARI Naylon 6.6	3	Ø 22 MM LEDLİ BUZZER (90dB)	33
ULTRAVİYOLE KABLO BAĞLARI	4	Ø 22 MM YAYLI BUTONLAR	34
PASLANMAZ ÇELİK KABLO BAĞLARI 304 ÇELİK	5	İŞARETLİ YAYLI BUTONLAR	34
PASLANMAZ POLYESTER KAPLI ÇELİK KABLO BAĞLARI 304 ÇELİK	5	LED IŞIKLI YAYLI BUTONLAR	34
VİDALI KABLO BAĞLARI	6	Ø 22 MM KALICI MANDAL BUTONLAR	35
DÜĞME BAŞLIKLİ KABLO BAĞLARI Naylon 6.6	6	Ø 22 MM KAYICI MANDAL BUTONLAR	35
PANELE KAFADAN SIKIŞAN KABLO BAĞLARI Naylon 6.6	6	Ø 22 MM KALICI-KAYICI MANDAL BUTONLAR	35
BONCUK KABLO BAĞLARI	6	Ø 22 MM ANAHTARLI KALICI BUTONLAR	35
AÇILABİLİR KABLO BAĞLARI	7	Ø 22 MM IŞIKLI KALICI MANDAL BUTONLAR	36
ETİKETLİ KABLO BAĞLARI Naylon 6.6	7	Ø 40 MM KALICI MANTAR BUTON (ACİL STOP)	36
METAL RULO KELEPÇE AISI 430	7	Ø 40 MM KALICI MANTAR LED IŞIKLI BUTONLAR	36
PASLANMAZ ÇELİK ETİKET 304 ÇELİK	8	Ø 40 MM KAYICI BUTONLAR	37
KABLO BAĞI ETİKET TAŞIYICI	8	Ø 40 MM KALICI ANAHTARLI BUTON	37
KABLO PANO ETİKETİ TAŞIYICI	8	İKİZ BUTONLAR	37
BASKILI DEVRE TAŞIYICILAR	9	JOYSTICK VİNC BUTON	37
BÜKÜLEBİLİR KLİPSİ	9	PANO İÇİ TERMOSTATLAR	38
FLAT KABLO TUTUCU	10	YEDEK KONTAK BLOKLARI	39
PLASTİK KABLO KELEPÇELERİ	10	BUTON AKSESUAR	39
YAPIŞKANLI KROŞE	11	KUTULU MONTAJLI ÜRÜNLER (STOP BUTON)	39
VİDALI KROŞE	11	DAĞITICI ÜNİTELER	40
DÜBEL KROŞE	11	DAĞITICI ÜNİTELER	41
YÜKSÜKLÜ BUAT KLEMENSİ (Kapama Parçası)	11	80A DAĞITICI ÜNİTELER 2 KUTUP KAPAKLI TİP (6,5X9mm)	41
HELEZON SİRALLER (Beyaz)	12	DAĞITICI ÜNİTELER	42
SİRALLER (Siyah)	12	125A DAĞITICI ÜNİTELER 2 KUTUP KAPAKLI TİP (7X12mm)	42
PVC İZOLE BANTLAR	13	80A DAĞITICI ÜNİTELER 3 KUTUP KAPAKLI TİP (7X12mm)	42
ERİYEN BANTLAR	13	125A DAĞITICI ÜNİTELER 3 KUTUP KAPAKLI TİP (7X12mm)	42
BUAT İÇİ YAYLI KLEMENSLER	14	DAĞITICI ÜNİTELER	43
ÇOK AMAÇLI KLEMENSLER (TIRNAKLI)	14	80A DAĞITICI ÜNİTELER 4 KUTUP KAPAKLI TİP (6,5X9mm)	43
KABLO PABUÇLARI	15	125A DAĞITICI ÜNİTELER 4 KUTUP KAPAKLI TİP (7X12mm)	43
& BARALAR	15	TOPRAKLAMA KLEMENSLERİ	44
TORK TİP2 SIKMALI KABLO PABUÇLARI	16	80A Ayaksız Pano Topraklama Klemensleri (6,5X9mm)	44
STANDART TİP SIKMALI KABLO PABUÇLARI	16	125A Ayaksız Pano Topraklama Klemensleri (7X12mm)	44
STANDART TİP SIKMALI KABLO PABUÇLARI	17	NÖTR KLEMENSLERİ	45
BAKIR EKMUFLAR	18	80A Ayaklı Pano Nötr Klemensleri (6,5X9mm)	45
ALÜMİNYUM SIKMALI KABLO PABUÇLARI	18	125A Ayaklı Pano Nötr Klemensleri (7x12mm)	45
ALÜMİNYUM EK MUF	19	ISI İLE DARALAN	46
U TİPİ KLEMENSLER	19	MAKARONLAR	46
BİMETALİK SIKMALI KABLO PABUÇLARI	20	MAKARONLAR	47
BİMETALİK EK MUF	20	ISI İLE DARALAN MAKARONLAR (2/1)	47
VİDALI BİMETALİK KABLO PABUÇLARI	21	MAKARONLAR	48
BİMETALİK PINLİ EKMUFLAR	21	ISI İLE DARALAN MAKARONLAR (2/1)	48
TRİFAZE MÜŞTEREK W OTOMAT BARALARI (İĞNE TİP)	22	MAKARONLAR	49
MONOFAZE MÜŞTEREK W OTOMAT BARALARI (İĞNE TİP)	22	RENKLİ ISI İLE DARALAN MAKARONLAR (2/1)	49
NÖTR TOPRAKLAMA BARALARI	22	MAKARONLAR	50
DELİKLİ SAC MONTAJ RAYLARI 35X7,5	23	RENKLİ ISI İLE DARALAN MAKARONLAR (2/1)	50
EŞ POTANSİYEL BARALAR	23	MAKARONLAR	51
NÖTR BARA MESNEDİ	23	İÇİ YAPIŞKANLI MAKARONLAR (3/1)	51
SAC RAY TAŞIYICI	23	KABLO TOPLAMA ÇORAPLARI	52
İZOLELİ KABLO	24	MEKANİK PABUÇ SIKMA PENSELERİ	54
YÜKSÜKLERİ	24	HİDROLİK PABUÇ SIKMA PENSELERİ	55
İZOLELİ KABLO YÜKSÜKLERİ - FRANSIZ NORMU DIN 46228	25	HİDROLİK PABUÇ SIKMA PENSELERİ	56
İZOLELİ KABLO YÜKSÜKLERİ - ALMAN NORMU DIN 46228	25	HİDROLİK PABUÇ SIKMA PENSELERİ	57
İZOLELİ ÇİFT GİRİŞLİ KABLO YÜKSÜKLERİ FRANSIZ NORMU DIN 46228	26	HİDROLİK PABUÇ SIKMA PENSELERİ	58
İZOLELİ ÇİFT GİRİŞLİ KABLO YÜKSÜKLERİ ALMAN NORMU DIN 46228	26	ŞARJ EDİLEBİLİR PİLLİ UNIVERSAL TİP PENSELER (PABUÇ SIKMA-KABLO KESME-PUNCH)	59
YUVARLAK TİP İZOLELİ KABLO UÇLARI	27	ŞARJ EDİLEBİLİR PİLLİ PABUÇ SIKMA/KESME PENSELERİ (DİKEY TİP)	60
ÇATAL TİP İZOLELİ KABLO UÇLARI	27	ŞARJ EDİLEBİLİR PİLLİ PABUÇ SIKMA PENSELERİ (YATAY TİP)	61
DİŞİ FASTON TİP İZOLELİ KABLO UÇLARI	28	MEKANİK KABLO KESME MAKASLARI (CİRCİRLİ TİP)	63
TAM İZOLELİ DİŞİ FASTON TİP KABLO UÇLARI	28	MEKANİK ÇELİK KESME MAKASLARI (CİRCİRLİ TİP)	64
İZOLELİ EKMUFLAR	28	MEKANİK KABLO KESME MAKASLARI	65
KURŞUN DİŞİ TERMİNALLER (Ekstra Bakır Yüksüklü)	29	HİDROLİK KABLO KESME MAKASLARI	66
KURŞUN ERKEK TERMİNALLER (Ekstra Bakır Yüksüklü)	29	HİDROLİK KABLO KESME BAŞLIKLARI	67
TAM İZOLELİ NAYLON BAYRAK TİP TERMİNALLER	29	ŞARJ EDİLEBİLİR PİLLİ KABLO KESME YENGEÇ Kafa MAKASLARI	68
ERKEK/DİŞİ GERİ DÖNÜŞLÜ TERMİNALLER	29	ŞARJ EDİLEBİLİR PİLLİ KABLO KESME MAKASLARI	69
İĞNE TİP İZOLELİ KABLO UÇLARI	30	MEKANİK EL ALETLERİ	72
ERKEK FASTON TİP TERMİNALLER (Ekstra Bakır Yüksüklü)	30	KONNEKTÖR SIKMA PENSESİ	74
İZOLESİZ KABLO YÜKSÜKLERİ DIN 46228	30	KABLO BAĞI SIKMA PENSELERİ	74
Ø 22 MM VOLTMETRE	33	KABLO SIYIRMA PENSELERİ	76
Ø 22 MM AMPERMETRE	33		

STANDART BEYAZ KABLO BAĞLARI Naylon 6.6

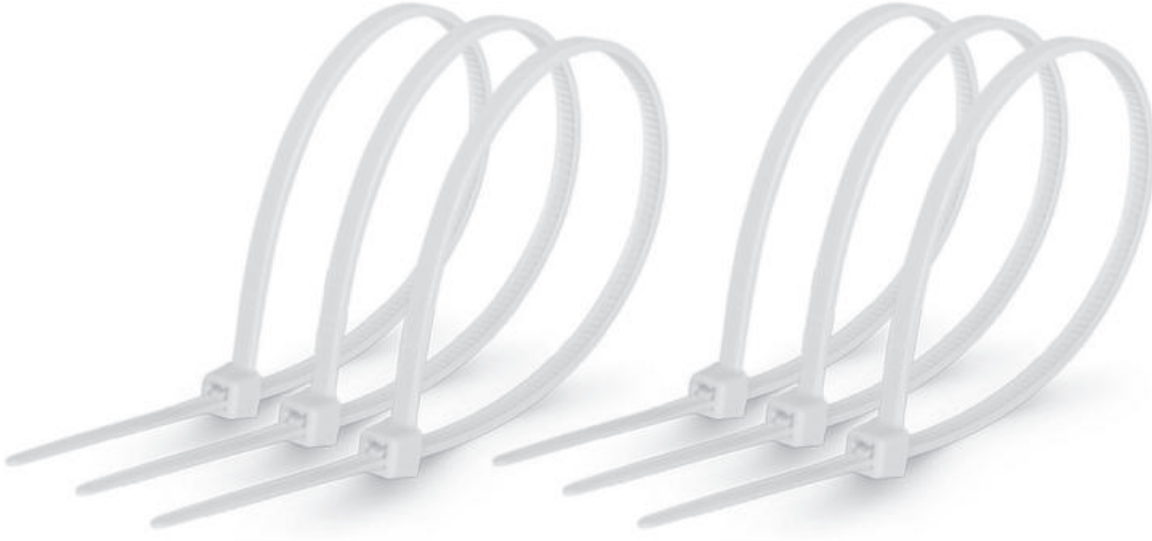

Ürün Kodu Beyaz	Ölçü		Max. Sıkma Çapı (mm)	Açılma Muk.	Poşet Miktarı (Ad)	Koli Miktarı (Ad)	Koli Ağırlığı (~kg)	Fiyat TL/Adet
	Uzunluk	En						
TKB-100M	100		25		100	50.000	12	0,140 -TL
TKB-150M	150	2,5	35	8kg	100	25.000	12	0,222 -TL
TKB-200M	203		55		100	25.000	16	0,304 -TL
TKB-140I	142		35		100	25.000	18	0,333 -TL
TKB-200I	203		55		100	22.000	21	0,437 -TL
TKB-250I	250	3,6	68	18kg	100	15.000	21	0,532 -TL
TKB-300I	292		85		100	15.000	23	0,660 -TL
TKB-370I	368		102		100	12.000	27	0,840 -TL
TKB-200S	203		55		100	13.000	17	0,620 -TL
TKB-250S	250		68		100	12.000	21	0,754 -TL
TKB-300S	300	4,8	85	22kg	100	10.000	21	0,918 -TL
TKB-370S	368		102		100	9.000	22	1,040 -TL
TKB-430S	430		125		100	8.500	25	1,420 -TL
TKB-300H	300		85		100	5.000	20	1,800 -TL
TKB-370H	368		102		100	4.500	22	1,985 -TL
TKB-450H	450	7,6	133	55kg	100	3.500	21	2,340 -TL
TKB-550H	550		166		100	3.500	26	3,080 -TL
TKB-610H	610		161		100	1.500	13	3,450 -TL
TKB-750H	750		223		100	1.500	17	4,770 -TL
TKB-610L	610		185		100	1.500	16	5,380 -TL
TKB-760L	762		236		100	1.500	19	6,250 -TL
TKB-920L	920	9,0	270	80kg	100	1.500	23	7,370 -TL
TKB-1020L	1020		295		100	1.000	17	7,660 -TL
TKB-1220L	1219		380		100	500	11	10,000 -TL
TKB-1530L	1530		450		100	500	11	21,000 -TL

Uygulama Sıcaklığı : -40°C+85°C (-40°F+185°F)
Naylon 6.6 UL94V-2

STANDART SİYAH KABLO BAĞLARI Naylon 6.6

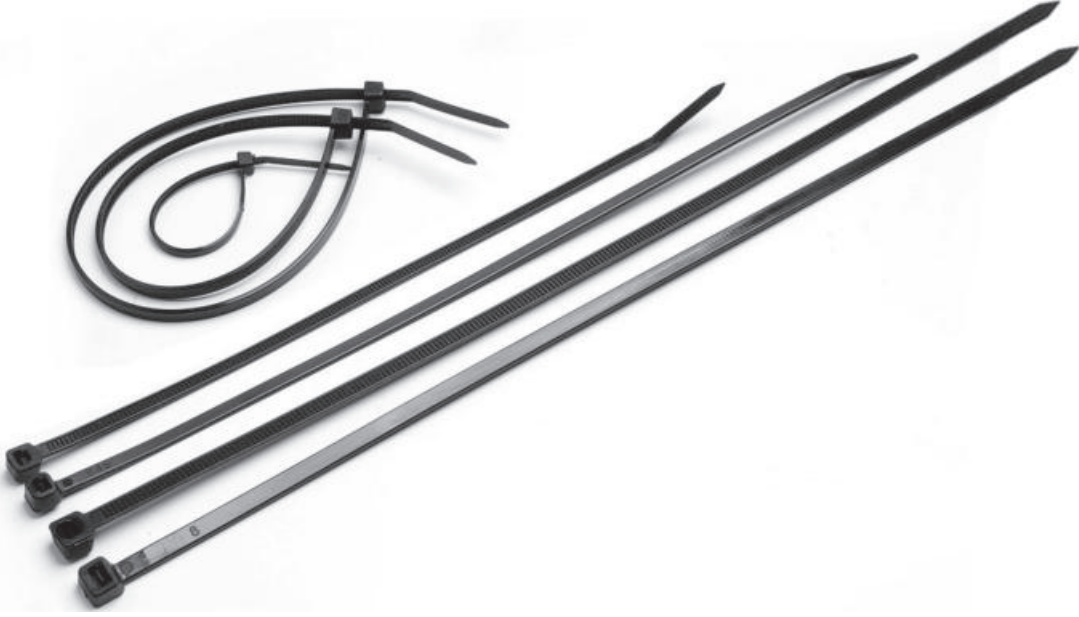

Ürün Kodu Siyah	Ölçü		Max. Sıkma Çapı (mm)	Açılma Muk.	Poşet Miktarı (Ad)	Koli Miktarı (Ad)	Koli Ağırlığı (~kg)	Fiyat TL/Adet
	Uzunluk	En						
TKB-100M-B	100		25		100	50.000	12	0,140 -TL
TKB-150M-B	150	2,5	35	8kg	100	25.000	12	0,222 -TL
TKB-200M-B	203		55		100	25.000	16	0,304 -TL
TKB-140I-B	142		35		100	25.000	18	0,333 -TL
TKB-200I-B	203		55		100	22.000	21	0,437 -TL
TKB-250I-B	250	3,6	68	18kg	100	15.000	21	0,532 -TL
TKB-300I-B	292		85		100	15.000	23	0,660 -TL
TKB-370I-B	368		102		100	12.000	27	0,840 -TL
TKB-200S-B	203		55		100	13.000	17	0,620 -TL
TKB-250S-B	250		68		100	12.000	21	0,754 -TL
TKB-300S-B	300	4,8	85	22kg	100	10.000	21	0,918 -TL
TKB-370S-B	368		102		100	9.000	22	1,040 -TL
TKB-430S-B	430		125		100	8.500	25	1,420 -TL
TKB-300H-B	300		85		100	5.000	20	1,800 -TL
TKB-370H-B	368		102		100	4.500	22	1,985 -TL
TKB-450H-B	450	7,6	133	55kg	100	3.500	21	2,340 -TL
TKB-550H-B	550		166		100	3.500	26	3,080 -TL
TKB-610H-B	610		161		100	1.500	13	3,450 -TL
TKB-750H-B	750		223		100	1.500	17	4,770 -TL
TKB-610L-B	610		185		100	1.500	16	5,380 -TL
TKB-760L-B	762		236		100	1.500	19	6,250 -TL
TKB-920L-B	920	9,0	270	80kg	100	1.500	23	7,370 -TL
TKB-1020L-B	1020		295		100	1.000	17	7,660 -TL
TKB-1220L-B	1219		380		100	500	11	10,000 -TL
TKB-1530L-B	1530		450		100	500	11	21,000 -TL

Uygulama Sıcaklığı : -40°C+85°C (-40°F+185°F)
Naylon 6.6 UL94V-2

ULTRAVİYOLE KABLO BAĞLARI



Ürün Kodu	Ölçü		Renk	Max. Sıkma Çapı (mm)	Açılma Mukavemeti	Poşet Miktarı (Ad)	Koli Miktarı (Ad)	Koli Ağırlığı (-kg)	Fiyat TL/Adet
	Uzunluk	En							
TKBUV-100M	100	2,5	Siyah	25	8	100	50.000	15	0,158 -TL
TKBUV-200M	203		Siyah	55		100	25.000	16	0,330 -TL
TKBUV-140I	142		Siyah	35		100	25.000	18	0,400 -TL
TKBUV-200I	203	3,6	Siyah	55	18	100	22.000	21	0,510 -TL
TKBUV-250I	250		Siyah	68		100	15.000	19	0,620 -TL
TKBUV-300I	292		Siyah	85		100	15.000	23	0,720 -TL
TKBUV-200S	203	4,8	Siyah	55	22	100	13.000	17	0,700 -TL
TKBUV-250S	250		Siyah	68		100	12.000	21	0,830 -TL
TKBUV-300S	310		Siyah	85		100	10.000	20	1,020 -TL
TKBUV-370S	368	7,6	Siyah	102	55	100	9.000	22	1,200 -TL
TKBUV-430S	432		Siyah	125		100	8.500	26	1,550 -TL
TKBUV-300H	300		Siyah	85		100	5.000	20	2,020 -TL
TKBUV-370H	368	9,0	Siyah	102	80	100	4.500	22	2,300 -TL
TKBUV-450H	450		Siyah	133		100	3.500	21	2,600 -TL
TKBUV-550H	550		Siyah	166		100	3.500	26	3,350 -TL
TKBUV-760L	762		Siyah	236		100	1.500	21	7,350 -TL

UV'ye dayanıklı kablo bağları, dış mekanlar için ideal bir seçenektir. Özellikle açık havada ve UV ışığına sürekli veya uzun süreli maruz kalan alanlarda kullanılmak üzere üretilmiştir. Hava koşullarındaki direnci yüksektir. UL94V-2 Dereceli olup UL tarafından belirlenen standartlara uygun olarak üretilmiştir..

Uygulama Sıcaklığı : -40°C+85°C (-40°F+185°F)
Naylon 6.6 UL94V-2

PASLANMAZ ÇELİK KABLO BAĞLARI 304 ÇELİK

Uygulama Sıcaklığı : -80°C+538°C (-112°F+1000°F)

Su Emilimi : YOK Ultraviole Dayanıklılığı : Mükemmel
Alev Yürümeme : UL94V-2 Kimyasal Dayanıklılık : Mükemmel



Ürün Kodu	Ölçü		Renk	Max. Sıkma Çapı (mm)	Açılma Mukavemeti	Poşet Miktarı (Ad)	Koli Miktarı (Ad)	Koli Ağırlığı (~kg)	Fiyat	
	Uzunluk	En							TL/Adet	
TKBC-150S	150	4,6	Metalik	46	90	100	5.000	11	2,400	-TL
TKBC-200S	200		Metalik	61,9		100	5.000	13	2,650	-TL
TKBC-250S	250		Metalik	81		100	5.000	15	2,920	-TL
TKBC-300S	300		Metalik	90,6		100	5.000	18	3,100	-TL
TKBC-370S	370		Metalik	112,8		100	2.500	11	3,440	-TL
TKBC-520S	520		Metalik	163,8		100	2.500	15	4,400	-TL
TKBC-680S	680		Metalik	214,8		100	1.000	8	5,200	-TL
TKBC-840S	840	Metalik	265,7	50	1.000	9	6,350	-TL		
TKBC-200H	200	7,9	Metalik	61	160	100	4.000	24	3,800	-TL
TKBC-300H	300		Metalik	90		100	4.000	26	4,500	-TL
TKBC-370H	370		Metalik	112		100	2.000	14	4,900	-TL
TKBC-520H	520		Metalik	163		100	1.000	10	6,200	-TL
TKBC-680H	680		Metalik	24		100	1.000	13	7,950	-TL
TKBC-840H	840		Metalik	265		50	1.000	15	8,800	-TL

PASLANMAZ POLYESTER KAPLI ÇELİK KABLO BAĞLARI 304 ÇELİK

Uygulama Sıcaklığı : -40°C+150°C (-40°F+302°F)

Su Emilimi : YOK Ultraviole Dayanıklılığı : Mükemmel
Alev Yürümeme : UL94V-2 Kimyasal Dayanıklılık : Mükemmel



Ürün Kodu	Uzunluk	En	Renk	Sıkma Çapı (mm)	Açılma Mukavemeti	Miktarı (Ad)	Miktarı (Ad)	Ağırlığı (~kg)	Fiyat	
									TL/Adet	
TKBCP-150S	150	4,6	Siyah	46	55	100	5.000	11	3,500	-TL
TKBCP-200S	200		Siyah	61,9		100	5.000	13	4,000	-TL
TKBCP-250S	250		Siyah	81		100	5.000	15	4,200	-TL
TKBCP-300S	300		Siyah	90,6		100	5.000	18	4,400	-TL
TKBCP-370S	370		Siyah	112,8		100	2.500	11	5,700	-TL
TKBCP-520S	520		Siyah	163,8		100	2.500	15	7,000	-TL
TKBCP-680S	680		Siyah	214,8		100	1.000	8	9,000	-TL
TKBCP-840S	840	Siyah	265,7	50	1.000	9	11,500	-TL		
TKBCP-200H	200	7,9	Siyah	61,9	120	100	4.000	24	5,050	-TL
TKBCP-300H	300		Siyah	90,6		100	4.000	26	6,200	-TL
TKBCP-370H	370		Siyah	112,8		100	2.000	14	7,300	-TL
TKBCP-520H	520		Siyah	163,8		100	1.000	10	10,100	-TL
TKBCP-680H	680		Siyah	214,8		100	1.000	13	13,500	-TL
TKBCP-840H	840		Siyah	265,7		50	1.000	15	16,000	-TL

ÇELİK KABLO BAĞI ÖZELLİKLERİ

* Kendinden kilitlenebilir kafa tasarımı, hızlı kurulum gövde boyunca herhangi bir boyda kilitlemeyi sağlar * Güçlü ve dayanıklı kablo bağlama yöntemi sağlar. * Çok çeşitli uygulama alanlarında kullanılabilir. * Pürüzsüz yüzeyi ve yuvarlatılmış uçları ile kablunun korunmasını ve işlevi yapan kişinin güvenliğini sağlar. * Şebeke kablolarında en üst düzey desteği sağlar.* Polyester Kaplıdır

VİDALI KABLO BAĞLARI



Ürün Kodu	Ölçü		Renk	Max. Sıkma Çapı (mm)	Açılma Mukavemeti	Poşet Miktarı (Ad)	Fiyat	
	Uzunluk	En					TL/Adet	-TL
TKBV-200S	200	4,8	Siyah	49,8	23	100	1,050	-TL

DÜĞME BAŞLIKLI KABLO BAĞLARI Naylon 6.6

*Naylon 6.6 UL94V-2. *Kablo demetlerinin bir panele sabitlenmesini sağlar .



Ürün Kodu	Ölçü		Renk	Max. Sıkma Çapı (mm)	Açılma Mukavemeti	Poşet Miktarı (Ad)	Fiyat	
	Uzunluk	En					TL/Adet	-TL
TKBD-370H	370	7,6	Siyah	103,5	65 kg	100	4,000	-TL

PANELE KAFADAN SIKIŞAN KABLO BAĞLARI Naylon 6.6

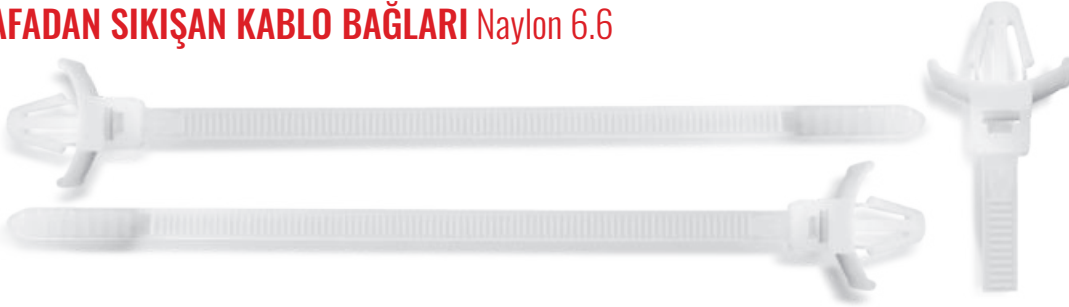

Ürün Kodu	Ölçü		Renk	Max. Sıkma Çapı (mm)	Açılma Mukavemeti	Poşet Miktarı (Ad)	Koli Miktarı (Ad)	Koli Ağırlığı (~kg)	Fiyat	
	Uzunluk	En							TL/Adet	-TL
TKBD-100M	100	2,5	Beyaz	25	8	100	15.000	10	0,433	-TL
TKBD-130S	130	4,8	Beyaz	35	18	100	5.000	7	0,770	-TL
TKBD-200S	200		Beyaz	50	22	100	5.000	9	1,300	-TL

BONCUK KABLO BAĞLARI



Ürün Kodu	Ölçü		Renk	Max. Sıkma Çapı (mm)	Açılma Mukavemeti	Poşet Miktarı (Ad)	Koli Miktarı (Ad)	Koli Ağırlığı (~kg)	Fiyat	
	Uzunluk	En							TL/Adet	-TL
TKBO-100M	100	2,5	Beyaz	25	8	100	50.000	16	0,270	-TL

AÇILABİLİR KABLO BAĞLARI



Ürün Kodu	Ölçü		Renk	Max. Sıkma Çapı (mm)	Açılma Mukavemeti	Poşet Miktarı (Ad)	Koli Miktarı (Ad)	Koli Ağırlığı (~kg)	Fiyat
	Uzunluk	En							TL/Adet
TKBA-200H	200	7,6	Beyaz	85	55	100	5.000	13	1,470 -TL
TKBA-370H	368		Beyaz	102		100	3.000	14	2,520 -TL

ETİKETLİ KABLO BAĞLARI Naylon 6.6

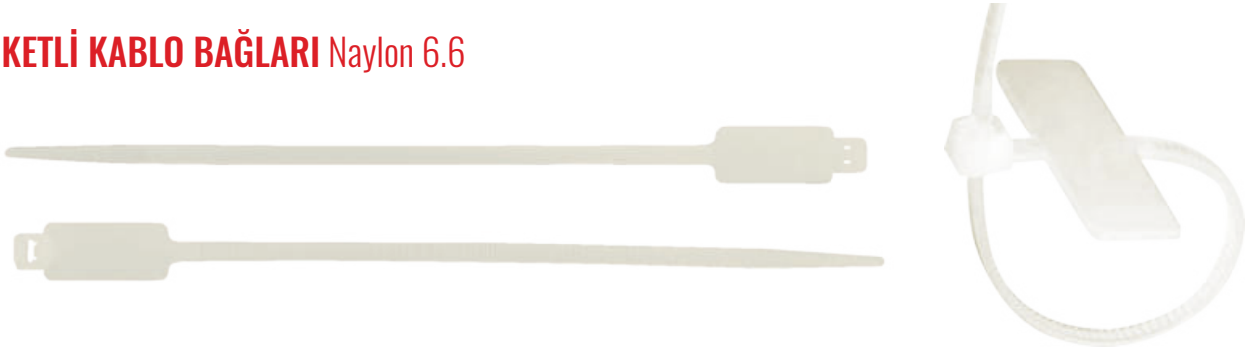

Ürün Kodu	Ölçü		Renk	Max. Sıkma Çapı (mm)	Açılma Mukavemeti	Poşet Miktarı (Ad)	Koli Miktarı (Ad)	Koli Ağırlığı (~kg)	Fiyat
	Uzunluk	En							TL/Adet
TKBE-100M	100	2,5	Beyaz	25	8kg	100	20.000	11	0,395 -TL
TKBE-200S	200	4,8	Beyaz	55	22kg	100	5.000	8	1,150 -TL

METAL RULO KELEPÇE AISI 430

Band Malzemesi

: Stainless Steel AISI 430 – X6Cr17 (430BA)
Çekme işlemine uygun soğuk haddelenmiş çelik

Kilitleme Cihazı Malzemesi

: DIN EN 10130:1999 – Çinko Kaplama Zn Cr+3 Sarı Pasivasyon

Kilitleme Vidası Malzemesi

: Cq15 Çinko Kaplama Cr+3 sarı pasivasyon



Ürün Kodu	Ürün Açıklaması	Malzeme	Renk	Band Genişliği (mm)	Band Kalınlığı (mm)	Band Uzunluğu (mt)	Koli Miktarı (Ad)	Koli Ağırlığı (~kg)	Fiyat TL/Adet
TMRK-9	9mm Metal Rulo Kelepçe	W2	Metalik	9	0,60	30	10	15,50	520,00 -TL
TMRK-12	12mm Metal Rulo Kelepçe	W2	Metalik	12	0,80	30	10	22,00	650,00 -TL

Ürün Kodu	Ürün Açıklaması	Koli Miktarı (Ad)	Koli Ağırlığı (~kg)	Fiyat TL/Adet
TMRK-9K	9mm Bağlantı Klipsi	500	6,5	11,70 -TL
TMRK-12K	12mm Bağlantı Klipsi	500	10,5	14,20 -TL

PASLANMAZ ÇELİK ETİKET 304 ÇELİK



Ürün Kodu	Ölçü		Genişlik (mm)	Bağ Eni (mm)	Renk	Poşet Miktarı (Ad)	Koli Miktarı (Ad)	Fiyat	
	Uzunluk	En						TL/Adet	-TL
TKBCE-1	19	90	0,75	4,6	Metalik	100	5.000	4,30	-TL

YAPIŞKANLI KABLO TUTUCU Naylon 6.6

* Uygulama Sıcaklığı : -30C°+85C° / *Naylon 6.6 UL94V-2

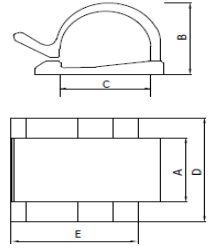

Ürün Kodu	A	B	C	D	E	Renk	Max. Kablo Çapı (mm)	Poşet Miktarı (Ad)	Fiyat	
									TL/Adet	-TL
TKBKT-12	12	11,5	11,9	26	26	Siyah	8	100	2,55	-TL
TKBKT-15	15,4	17,1	18,1	25	25	Siyah	16	100	3,00	-TL

KABLO BAĞI ETİKET TAŞIYICI



Ürün Kodu	Ölçü				Renk	Poşet Miktarı (Ad)	Koli Miktarı (Ad)	Koli Ağırlığı (-kg)	Fiyat	
	W	L	H	W1					TL/Adet	-TL
TKE-1	32,6	11,5	3	5,0	Beyaz	100	10.000	11	1,10	-TL
TKE-2	43,5	19,1	4,6	5,1	Beyaz	100	4.500	13	1,80	-TL

KABLO PANO ETİKETİ TAŞIYICI



Ürün Kodu	Ölçü		Renk	Poşet Miktarı (Ad)	Koli Miktarı (Ad)	Fiyat	
	Uzunluk	En				TL/Adet	-TL
TYPE-01		30	Siyah	100	3.000	4,40	-TL
TYPE-02	17	52	Siyah	100	3.000	5,25	-TL
TYPE-03		70	Siyah	50	2.000	6,20	-TL

BASKILI DEVRE TAŞIYICILAR

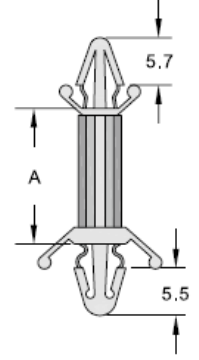

Ürün Kodu	A	Delik Çapı (mm)	Kalınlık (mm)	Renk	Poşet Miktarı (Ad)	Koli Miktarı (Ad)	Koli Ağırlığı (-kg)	Fiyat TL/Adet
TBDT-06	6,4 (1/4")	4	1,8	Beyaz	100	40.000	18	0,720 -TL
TBDT-09	9,3 (3/8")	4	1,8	Beyaz	100	35.000	19	0,590 -TL
TBDT-13	12,7 (1/2")	4	1,8	Beyaz	100	30.000	18	0,640 -TL
TBDT-16	15,9 (5/8")	4	1,8	Beyaz	100	25.000	16	0,720 -TL
TBDT-19	19,1 (3/4")	4	1,8	Beyaz	100	25.000	18	1,350 -TL

BÜKÜLEBİLİR KLİPSİ

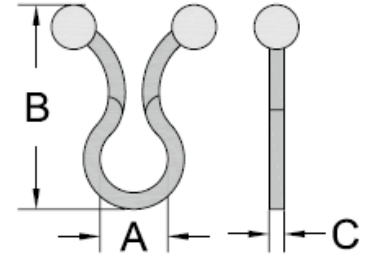

Ürün Kodu	Çap (mm)	Boy (mm) B	En (mm) C	Bağlama Çapı	Poşet Miktarı (Ad)	Koli Miktarı (Ad)	Koli Ağırlığı (-kg)	Fiyat TL/Adet
TBK-05	5,10	21,6	1,5	4,4	100	55.000	20	0,515 -TL
TBK-08	8,00	25,0	2,0	7,0	100	35.000	17	0,630 -TL
TBK-11	11,60	29,8	1,7	10,1	100	40.000	17	0,720 -TL
TBK-15	15,00	33,8	1,9	13,4	100	20.000	13	1,050 -TL
TBK-18	18,60	40,0	1,9	16,2	100	16.000	16	1,290 -TL
TBK-24	23,60	45,0	2,0	21,3	100	15.000	14	1,400 -TL

FLAT KABLO TUTUCU

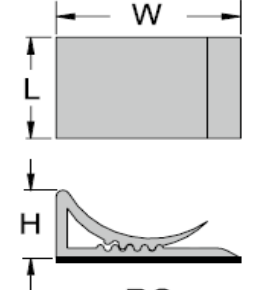
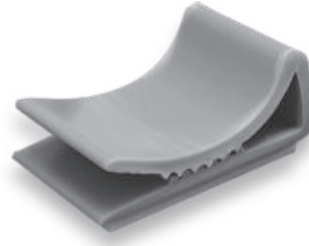
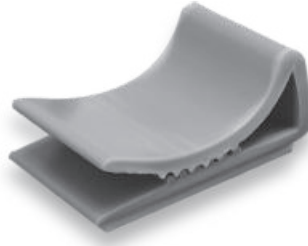
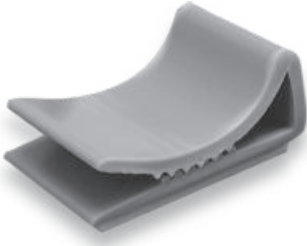

Ürün Kodu	Ölçü			Renk	Poşet Miktarı (Ad)	Koli Miktarı (Ad)	Koli Ağırlığı (-kg)	Fiyat
	W	L	H					TL/Adet
TYFC-15	24	15	9	Gri	100	12.000	27	2,700 -TL
TYFC-25	24	25	9	Gri	100	7.500	28	3,570 -TL

PLASTİK KABLO KELEPÇELERİ

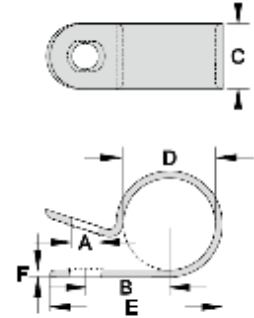

Ürün Kodu	A	B	C	D	E	F	B	En C (mm)	Poşet Miktarı (Ad)	Koli Miktarı (Ad)	Koli Ağırlığı (-kg)	Fiyat TL/Adet
TPKL-03	4,8	8	9,6	3,1 (1/8")	16,9	1,05	16,9	9,6	100	40.000	17	0,515 -TL
TPKL-05	4,8	9,2	9,6	5,0 (3/16")	18,5	1,05	18,6	9,6	100	35.000	19	0,520 -TL
TPKL-06	4,6	10,4	10,1	6,35 (1/4")	20	1,1	20,0	10,0	100	25.000	16	0,470 -TL
TPKL-08	5	11,2	10	7,9 (5/16")	22,6	1,15	22,0	10,0	100	20.000	14	0,650 -TL
TPKL-10	5	12,5	12,3	9,5 (3/8")	26,6	1,4	24,0	12,0	100	12.000	14	0,590 -TL
TPKL-13	5	14,8	12,2	12,7 (1/2")	30,3	1,4	31,0	12,0	100	9.000	14	1,000 -TL
TPKL-16	5	15,8	12,4	15,8 (5/8")	32,6	1,4	34,3	12,0	100	8.000	15	1,230 -TL
TPKL-19	4,8	18	11,8	19,4 (3/4")	37,3	1,4	35,0	12,0	100	6.000	12	1,700 -TL
TPKL-25	5	21	12	25,4 (1")	43,4	1,4	43,0	12,0	100	4.500	10	2,000 -TL
TPKL-28	4,8	26	12,6	27,5 (1 1/16")	51,5	1,7	50,0	12,0	100	3.000	10	2,150 -TL
TPKL-32	4,7	26	12	31,8 (1 1/4")	52,3	1,6	46,2	12,0	100	3.000	12	2,250 -TL
TPKL-38	4,8	27,8	12,5	36,7 (1 1/2")	58,3	1,5	50,0	12,0	100	2.500	10	2,690 -TL

YAPIŞKANLI KROŞE

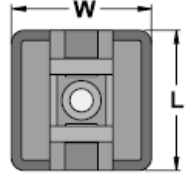
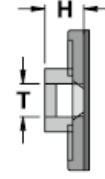
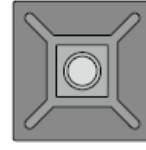
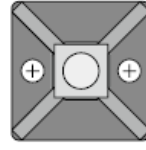

Ürün Kodu	Ölçü				Montaj Delik Çapı (mm)	Renk	Taşıma Mukavemeti	Poşet Miktarı (Ad)	Koli Miktarı (Ad)	Koli Ağırlığı (~kg)	Fiyat	
	L	W	H	T							TL/Adet	
TYK1919	19,5	19,5	3,9	4,6	3,2	Beyaz	10kg	100	20.000	18	0,600	-TL
TYK1919-B	19,5	19,5	3,9	4,6	3,2	Siyah	10kg	100	20.000	18	0,600	-TL
TYK2828	28,6	28,6	5,3	5,5	5,0	Beyaz	16kg	100	5.000	11	1,050	-TL
TYK2828-B	28,6	28,6	5,3	5,5	5,0	Siyah	16kg	100	5.000	11	1,050	-TL

VİDALI KROŞE

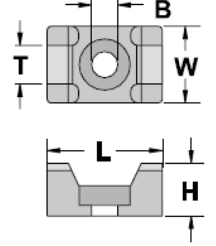

Ürün Kodu	Ölçü					Renk	Poşet Miktarı (Ad)	Koli Miktarı (Ad)	Koli Ağırlığı (~kg)	Fiyat	
	H	L	W	T	B					TL/Adet	
TVK1	7	15	10	5,1	3,5	Beyaz	100	3.000	3	0,450	-TL
TVK2	9,8	23	16	9,0	6,3	Beyaz	100	3.000	7	0,700	-TL

DÜBEL KROŞE

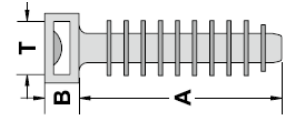
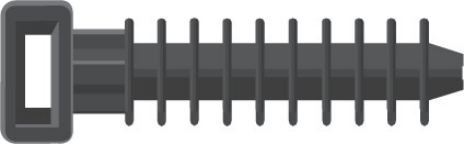

Ürün Kodu	Ölçü			Montaj Delik Çapı (mm)	Renk	Poşet Miktarı (Ad)	Koli Miktarı (Ad)	Koli Ağırlığı (~kg)	Fiyat	
	A	B	T						TL/Adet	
TDK8	37,5	6,3	9,7	9	Siyah	100	7.500	17	0,800	-TL

YÜKSÜKLÜ BUAT KLEMENSİ (Kapama Parçası)

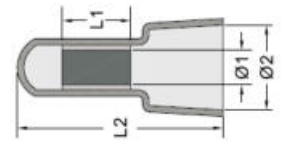

Ürün Kodu	Renk	L1	L2	Q1	Q2	Boy	Çap 1	Çap 2	Ambalaj Miktarı (Ad)	Koli Miktarı (Ad)	Fiyat	
											TL/Adet	
TKPM2	Beyaz	7,5	20,0	3,0	7,8	20,0	3,0	7,8	100	40.000	0,265	-TL
TKPM5	Beyaz	8,5	25,3	3,8	10,5	25,3	3,8	10,5	100	18.000	0,580	-TL

HELEZON SPİRALLER (Beyaz)

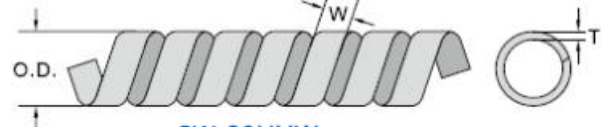

Ürün Kodu		O.D.	T	W	Kablo Kesit mm ²	Renk	Paket Miktarı (Mt)	Koli Miktarı (Mt)	Fiyat TL/Metre
TSPR-06	(No1)	6	0,6	7,4	2,5 - 15	Beyaz	10 mt	1.000 mt	2,880 -TL
TSPR-08	(No2)	8	0,75	12	6 - 30		10 mt	800 mt	3,400 -TL
TSPR-10	(No3)	10	0,8	12,3	7,5 - 30		10 mt	500 mt	4,440 -TL
TSPR-12	(No4)	12	0,85	15	9 - 32		10 mt	400 mt	5,750 -TL
TSPR-15	(No5)	15	1	15,5	12 - 35		10 mt	250 mt	9,500 -TL

Malzeme : PE

Esnek yapısı sayesinde kabloların düzenlenmesine yardımcı olur
Güçlü yapısı sayesinde tekrar kullanım için uygundur
Spiral uçlarını TORX kablo bağları ile sabitleyebilirsiniz

SPİRALLER (Siyah)

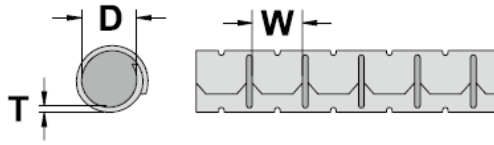

Ürün Kodu		D	T	W	Kablo Kesit mm ²	Renk	Paket Miktarı (Mt)	Koli Miktarı (Mt)	Fiyat TL/Metre
TTSPR-08		8	0,8	9	10	Siyah	5 mt	750 mt	26,000 -TL
TTSPR-15		15	0,8	13	16		5 mt	350 mt	32,500 -TL
TTSPR-20		20	0,9	15	22		5 mt	275 mt	53,000 -TL
TTSPR-25		25	1,3	18	27		5 mt	150 mt	70,000 -TL
TTSPR-32		32	1,3	23	35		5 mt	90 mt	140,00 -TL

Malzeme : PP

Kabloların dış etkenlerden korunmasını sağlar ve kolay uygulanabilir.
Güçlü yapısı sayesinde tekrar kullanım için uygundur

PVC İZOLE BANTLAR



Özellikler

- * Elektrik yalıtımı ve kablo bağlantısı için en iyi kalite
- * Alev geciktirici
- * Soğuğa dayanıklı
- * Reach / Rohs uyumlu
- * -18 °C +105 °C

Ürün Kodu	Renk	Boy	Koli Miktarı (Ad)	Fiyat USD/Adet
TPVC-19	SİYAH			0,55 -USD
TPVC-19K	KIRMIZI			0,55 -USD
TPVC-19B	BEYAZ			0,55 -USD
TPVC-19G	GRİ			0,55 -USD
TPVC-19Y	YEŞİL	0,13 x 19 x 10 yds	500	0,55 -USD
TPVC-19S	SARI			0,55 -USD
TPVC-19M	MAVİ			0,55 -USD
TPVC-19SY	SARI - YEŞİL			0,65 -USD

Ürün Kodu	Renk	Boy	Koli Miktarı (Ad)	Fiyat USD/Adet
TPVC-50	SİYAH	0,13 x 50 x 25 yds	80	3.10 -USD

ERİYEN BANTLAR



Ürün Kodu	Renk	Boy	Koli Miktarı (Ad)	Fiyat USD/Adet
TSFT-19	Siyah	19x0,8x8m	60	3.00 -USD
TSFT-50	Siyah	50x0,8x8m	24	8.70 -USD

BUAT İÇİ YAYLI KLEMENSLER



Özellikler

Akım	: 24A
Gerilim	: 450V
İletken Tipi	: Tek Damarlı Rigid
İletken Kesiti	: 1,0 - 2,5 mm ²
Min. Çalışma Sıcaklığı	: -30°C
Max. Çalışma Sıcaklığı	: +110°C
Gövde	: (PC) Halogen Free

Ürün Kodu	Renk	Kablo Kesiti	En	Boy	Ambalaj Miktarı (Ad)	Koli Miktarı (Ad)	Fiyat TL/Adet
TBKY-02	Kırmızı	1,0 - 2,5	10,5	19,5	200	10.000	2,100 -TL
TBKY-03	Turuncu	1,0 - 2,5	13,5	19,7	200	10.000	2,250 -TL
TBKY-04	Sarı	1,0 - 2,5	17,2	19,7	100	5.000	2,650 -TL
TBKY-05	Gri	1,0 - 2,5	21,1	19,7	100	5.000	2,900 -TL
TBKY-06	Beyaz	1,0 - 2,5	13,8	16,4	100	5.000	3,600 -TL
TBKY-08	Siyah	1,0 - 2,5	17,5	19,0	100	5.000	4,550 -TL

Uygulama Yerleri

Anahtar Kasaları
Dağıtım Kutuları
Elektrik Panoları
Aydınlatma Armatürleri
Güvenlik /Alarm Sistemleri
Prefabrik Kabloleme Sistemleri

ÇOK AMAÇLI KLEMENSLER (TIRNAKLI)



Özellikler

Akım	: 32A
Gerilim	: 450V
İletken Tipi	: Tek Damarlı Rigid
İletken Kesiti	: 0,4 - 4,0 mm ²
Min. Çalışma Sıcaklığı	: -30°C
Max. Çalışma Sıcaklığı	: +110°C
Gövde	: (PC)(PA) Halogen Free & Alev Yayımayan



Ürün Kodu	Renk	Kablo Kesiti	Ölçüler	Ambalaj Miktarı (Ad)	Koli Miktarı (Ad)	Fiyat TL/Adet
TBKCA-412	Turuncu	0,5-4	18,2 x 13 x 9,8 mm	100	5.000	4,000 -TL
TBKCA-413	Turuncu	0,5-4	18,2 x 18,6 x 9,8 mm	100	5.000	5,000 -TL
TBKCA-414	Turuncu	0,5-4	18,2 x 24,2 x 9,8 mm	50	2.500	6,250 -TL
TBKCA-415	Turuncu	0,5-4	18,2 x 29,9 x 9,8 mm	50	2.500	7,400 -TL

"maximum enerji maximum **TORK**"



KABLO PABUÇLARI & BARALAR

TORK TİP2 SIKMALI KABLO PABUÇLARI



Malzeme: EN 13600
Yüzey: Kalay Kaplı

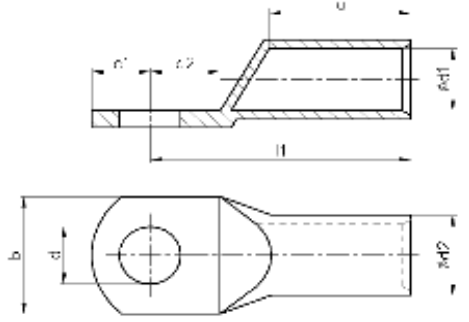

Ürün Kodu	Kablo Kesiti mm ²	Civata Ø	Ebatlar (mm)								Ambalaj Miktarı (Ad)	Fiyat	
			d	d1	d2	l1	a	b	c1	c2		TL/Adet	
TSKPT2-01606	16 mm ²	M6	6,5	5,5	7,0	24,0	12,5	10,5	7,5	7,5	500	3,950	-TL
TSKPT2-02508	25 mm ²	M8	8,5	7,0	9,0	30,5	17,5	13,0	8,5	8,5	350	7,700	-TL
TSKPT2-03508	35 mm ²	M8	8,5	8,5	10,5	34,0	18,5	15,5	9,5	9,5	200	10,400	-TL
TSKPT2-05010	50 mm ²	M10	10,5	10,0	12,0	39,5	20,0	18,0	11,0	11,0	150	14,200	-TL
TSKPT2-07010	70 mm ²	M10	10,5	11,5	14,0	42,0	22,0	20,5	11,0	11,0	100	20,800	-TL
TSKPT2-09512	95 mm ²	M12	13,0	13,5	16,0	48,0	25,0	23,5	12,0	12,5	80	25,800	-TL
TSKPT2-12012	120 mm ²	M12	13,0	15,5	18,0	52,0	27,0	27,0	14,0	14,0	50	37,500	-TL
TSKPT2-15012	150 mm ²	M12	13,0	16,5	20,0	54,5	29,0	29,0	14,0	14,0	40	55,800	-TL
TSKPT2-18516	185 mm ²	M16	17,0	18,5	22,0	61,5	32,0	32,0	14,5	14,5	30	70,500	-TL
TSKPT2-24016	240 mm ²	M16	17,0	21,5	25,5	69,0	36,5	37,5	16,0	16,0	25	104,000	-TL

*Ürünlerimiz elektrolitik bakırdan (E-Cu), tam tavlı, havşalı ve minimum 3 mikron kalay kaplıdır.

STANDART TİP SIKMALI KABLO PABUÇLARI



Malzeme: EN 13600
Yüzey: Kalay Kaplı

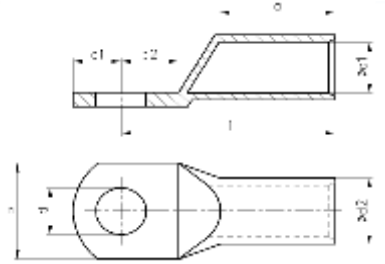

Ürün Kodu	Kablo Kesiti mm ²	Civata Ø	Ebatlar (mm)								Ambalaj Miktarı (Ad)	Fiyat	
			d	d1	d2	l1	a	b	c1	c2		TL/Adet	
TSKP- 01005	10 mm ²	M5	5,5	4,5	6,5	22,0	11,5	10,0	7,0	7,0	800	4,000	-TL
TSKP- 01006		M6	6,5	4,5	6,5	22,0	11,5	11,0	7,0	7,0	800	4,000	-TL
TSKP- 01008		M8	8,5	4,5	6,5	23,0	11,5	13,5	8,0	8,0	800	4,000	-TL
TSKP- 01606	16 mm ²	M6	6,5	5,5	7,5	24,0	12,5	12,0	7,5	7,5	500	5,500	-TL
TSKP- 01608		M8	8,5	5,5	7,5	25,5	13,0	13,5	8,0	8,0	500	6,100	-TL
TSKP- 01610		M10	10,5	5,5	7,5	25,5	13,0	16,0	9,0	9,0	500	6,100	-TL
TSKP- 02506	25 mm ²	M6	6,5	7,0	9,5	30,5	17,0	14,0	8,5	8,5	350	10,200	-TL
TSKP- 02508		M8	8,5	7,0	9,5	30,5	17,0	14,0	8,5	8,5	350	10,200	-TL
TSKP- 02510		M10	10,5	7,0	9,5	31,5	17,0	16,0	10,0	10,0	350	10,500	-TL
TSKP- 03506	35 mm ²	M6	6,5	8,5	11,0	34,5	19,0	16,0	9,5	9,5	200	13,400	-TL
TSKP- 03508		M8	8,5	8,5	11,0	34,5	19,0	16,0	9,5	9,5	200	13,400	-TL
TSKP- 03510		M10	10,5	8,5	11,0	35,0	19,0	16,5	10,0	10,0	200	15,000	-TL
TSKP- 03512		M12	13,0	8,5	11,0	37,0	19,0	18,0	11,0	11,0	200	15,000	-TL

*Ürünlerimiz elektrolitik bakırdan (E-Cu), tam tavlı, havşalı ve minimum 3 mikron kalay kaplıdır.

STANDART TİP SIKMALI KABLO PABUÇLARI



Malzeme: EN 13600
Yüzey: Kalay Kaplı

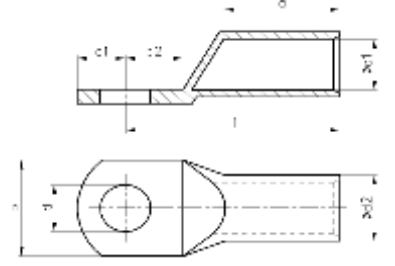

Ürün Kodu	Kablo Kesiti mm ²	Cıvata Ø	Ebatlar (mm)								Ambalaj Miktarı (Ad)	Fiyat	
			d	d1	d2	l1	a	b	c1	c2		TL/Adet	
TSKP- 05006	50 mm ²	M6	6,5	10,0	13,0	40,0	21,0	19,0	11,0	11,0	150	20,000	-TL
TSKP- 05008		M8	8,5	10,0	13,0	40,0	21,0	19,0	11,0	11,0	150	20,000	-TL
TSKP- 05010		M10	10,5	10,0	13,0	40,0	21,0	19,0	11,0	11,0	150	20,750	-TL
TSKP- 05012		M12	13,0	10,0	13,0	40,0	21,0	19,0	11,0	11,0	150	20,750	-TL
TSKP- 07008	70 mm ²	M8	8,5	11,5	14,5	41,5	23,0	21,5	11,0	11,0	100	28,400	-TL
TSKP- 07010		M10	10,5	11,5	14,5	41,5	23,0	21,5	11,0	11,0	100	28,400	-TL
TSKP- 07012		M12	13,0	11,5	14,5	41,5	23,0	21,5	11,0	11,0	100	28,400	-TL
TSKP- 07014		M14	15,0	11,5	14,5	41,5	23,0	21,5	11,0	11,0	100	34,000	-TL
TSKP- 09508	95 mm ²	M8	8,5	13,5	16,5	48,0	26,0	24,0	12,0	12,5	80	35,750	-TL
TSKP- 09510		M10	10,5	13,5	16,5	48,0	26,0	24,0	12,0	12,5	80	35,750	-TL
TSKP- 09512		M12	13,0	13,5	16,5	48,0	26,0	24,0	12,0	12,5	80	35,750	-TL
TSKP- 09514		M14	15,0	13,5	16,5	48,0	26,0	24,0	12,0	12,5	80	37,000	-TL
TSKP- 12010	120 mm ²	M10	10,5	14,5	18,0	52,0	27,0	26,0	14,0	14,0	50	48,000	-TL
TSKP- 12012		M12	13,0	14,5	18,0	52,0	27,0	26,0	14,0	14,0	50	48,000	-TL
TSKP- 12014		M14	15,0	14,5	18,0	52,0	27,0	26,0	14,0	14,0	50	53,250	-TL
TSKP- 12016		M16	17,0	14,5	18,0	52,0	27,0	26,0	14,0	14,0	50	53,250	-TL
TSKP- 15010	150 mm ²	M10	10,5	16,5	21,0	57,0	30,0	30,0	15,0	15,0	40	74,300	-TL
TSKP- 15012		M12	13,0	16,5	21,0	57,0	30,0	30,0	15,0	15,0	40	74,300	-TL
TSKP- 15014		M14	15,0	16,5	21,0	57,0	30,0	30,0	15,0	15,0	40	75,000	-TL
TSKP- 15016		M16	17,0	16,5	21,0	57,0	30,0	30,0	15,0	15,0	40	75,000	-TL
TSKP- 18510	185 mm ²	M10	10,5	18,5	23,0	65,5	33,5	34,0	17,0	18,0	30	96,500	-TL
TSKP- 18512		M12	13,0	18,5	23,0	65,5	33,5	34,0	17,0	18,0	30	96,500	-TL
TSKP- 18514		M14	15,0	18,5	23,0	65,5	33,5	34,0	17,0	18,0	30	96,500	-TL
TSKP- 18516		M16	17,0	18,5	23,0	65,5	33,5	34,0	17,0	18,0	30	96,000	-TL
TSKP- 24010	240 mm ²	M10	10,5	21,0	26,0	72,0	39,0	38,0	17,0	18,0	25	125,500	-TL
TSKP- 24012		M12	13,0	21,0	26,0	72,0	39,0	38,0	17,0	18,0	25	125,500	-TL
TSKP- 24014		M14	15,0	21,0	26,0	72,0	39,0	38,0	17,0	18,0	25	125,500	-TL
TSKP- 24016		M16	17,0	21,0	26,0	72,0	39,0	38,0	17,0	18,0	25	125,000	-TL
TSKP- 30010	300 mm ²	M10	10,5	23,5	28,5	77,0	41,0	42,0	19,0	19,0	20	151,500	-TL
TSKP- 30012		M12	13,0	23,5	28,5	77,0	41,0	42,0	19,0	19,0	20	151,500	-TL
TSKP- 30014		M14	15,0	23,5	28,5	77,0	41,0	42,0	19,0	19,0	20	151,500	-TL
TSKP- 30016		M16	17,0	23,5	28,5	77,0	41,0	42,0	19,0	19,0	20	150,000	-TL
TSKP- 40012	400 mm ²	M14	15,0	27,0	33,0	88,0	49,0	48,0	20,0	20,0	12	335,000	-TL
TSKP- 40016		M16	17,0	27,0	33,0	88,0	49,0	48,0	20,0	20,0	12	330,000	-TL
TSKP- 40020		M20	21,0	27,0	33,0	88,0	49,0	48,0	20,0	20,0	12	330,000	-TL
TSKP- 50016	500 mm ²	M16	17,0	30,0	38,0	96,0	52,0	55,0	22,0	22,0	8	550,000	-TL
TSKP- 50020		M20	21,0	30,0	38,0	96,0	52,0	55,0	22,0	22,0	8	550,000	-TL
TSKP- 60020	600 mm ²	M20	21,0	34,0	42,0	113,0	60,0	61,0	23,0	23,0	6	Fiyat Sorunuz.	

* Ürünlerimiz elektrolitik bakırdan (E-Cu), tam tavlı, havşalı ve minimum 3 mikron kalay kaplıdır.

* %99,9 oranında iletkenliğe sahiptir.

* Gri renk ile belirtilen kalemler standart ürün grubumuzdur.

* Özel ölçülerimiz için bilgi alınız.

BAKIR EKMUŞ



Ürün Kodu	Kablo Kesiti mm ²	Ebatlar (mm)			Ambalaj Miktarı (Ad)	Fiyat	
		d1	d2	L		TL/Adet	
TMUFS-016	16 mm ²	5,5	7,0	32,0	400	4,000	-TL
TMUFS-025	25 mm ²	7,0	9,0	40,0	250	7,900	-TL
TMUFS-035	35 mm ²	8,5	10,5	45,0	200	10,500	-TL
TMUFS-050	50 mm ²	10,0	12,0	50,0	150	14,000	-TL
TMUFS-070	70 mm ²	11,5	14,0	55,0	100	21,000	-TL
TMUFS-095	95 mm ²	13,5	16,0	60,0	50	26,000	-TL
TMUFS-120	120 mm ²	15,5	18,0	65,0	50	37,500	-TL
TMUFS-150	150 mm ²	16,5	20,0	70,0	40	56,000	-TL
TMUFS-185	185 mm ²	18,5	22,0	75,0	25	70,000	-TL
TMUFS-240	240mm ²	21,5	25,5	85,0	20	100,000	-TL
TMUFS-300	300mm ²	23,5	28,5	100,0	15	150,000	-TL

ALÜMİNYUM SIKMALI KABLO PABUÇLARI



Ürün Kodu	Kablo Kesiti mm ²	Cıvata Ø	Ebatlar (mm)		Ambalaj Miktarı (Ad)	Fiyat	
			Dış Çap	Uzunluk		TL/Adet	
TSKPAL-01606	16 mm ²	M6	10	60	200	0,360	-USD
TSKPAL-02508	25 mm ²	M8	12	70	150	0,565	-USD
TSKPAL-03508	35 mm ²	M8	14	76	100	0,860	-USD
TSKPAL-05010	50 mm ²	M10	16	83	75	1,180	-USD
TSKPAL-07012	70 mm ²	M12	18	97	50	1,450	-USD
TSKPAL-09512	95 mm ²	M12	22	109	50	1,900	-USD
TSKPAL-12012	120 mm ²	M12	22	109	40	2,250	-USD
TSKPAL-15012	150 mm ²	M12	26	118,5	25	3,700	-USD
TSKPAL-18512	185 mm ²	M12	28	125,5	20	4,100	-USD
TSKPAL-24012	240 mm ²	M12	32	141,5	20	4,400	-USD

ALÜMİNYUM EK MUF



Ürün Kodu	Kablo Kesiti mm ²	Ebatlar (mm)			Ambalaj Miktarı (Ad)	Fiyat TL/Adet
		d1	d2	L		
TMUFA-016	16 mm ²	5,5	7,0	32,0	200	0,360 -USD
TMUFA-025	25 mm ²	7,0	9,0	40,0	125	0,565 -USD
TMUFA-035	35 mm ²	8,5	10,5	45,0	100	0,860 -USD
TMUFA-050	50 mm ²	10,0	12,0	50,0	75	1,180 -USD
TMUFA-070	70 mm ²	11,5	14,0	55,0	50	1,450 -USD
TMUFA-095	95 mm ²	13,5	16,0	60,0	40	1,900 -USD
TMUFA-120	120 mm ²	15,5	18,0	65,0	25	2,250 -USD
TMUFA-150	150 mm ²	16,5	20,0	70,0	20	3,700 -USD
TMUFA-185	185 mm ²	18,5	22,0	75,0	15	4,100 -USD
TMUFA-240	240mm ²	21,5	25,5	85,0	15	4,400 -USD

U TİPİ KLEMENSLER



Ürün Kodu	Ürün Cinsi	Ambalaj Miktarı (Ad)	Fiyat
			TL/Adet
UK-006	6 mm ² U Tipi Klemens	300	12,50 -TL
UK-010	10 mm ² U Tipi Klemens	250	16,50 -TL
UK-016	16 mm ² U Tipi Klemens	125	25,50 -TL
UK-025	25 mm ² U Tipi Klemens	100	30,50 -TL
UK-035	35 mm ² U Tipi Klemens	75	36,00 -TL
UK-050	50 mm ² U Tipi Klemens	50	65,00 -TL
UK-070	70 mm ² U Tipi Klemens	40	78,00 -TL
UK-095	95 mm ² U Tipi Klemens	25	93,50 -TL
UK-120	120 mm ² U Tipi Klemens	25	125,00 -TL
UK-150	150 mm ² U Tipi Klemens	15	165,00 -TL

BİMETALİK SIKMALI KABLO PABUÇLARI

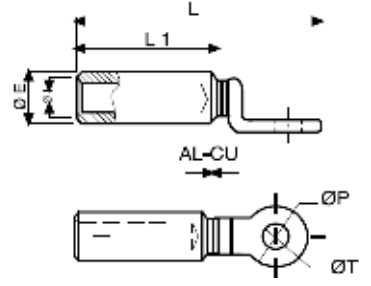
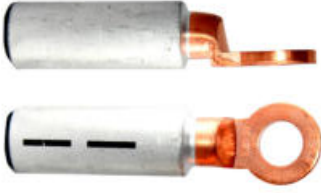

Elektrolitik Bakır 99,9
İletkenlik katsayısı min. 56 ms / m

Ürün Kodu	Kablo Kesiti mm ²	Cıvata Ø	Ebatlar (mm)					Ağırlık (kg)	Ambalaj Miktarı (Ad)	Fiyat	
			Ø E	Ø I	L	Ø T	L1			USD/Adet	
TSKPBM-01610	16 mm ²	M10	20,0	6,5	84,0	12,8	46,0	7,2	100	2,500	-USD
TSKPBM-02510	25 mm ²	M10	20,0	6,5	84,0	12,8	46,0	7,2	100	2,500	-USD
TSKPBM-03510	35 mm ²	M10	20,0	8,0	84,0	12,8	46,0	7,2	100	2,500	-USD
TSKPBM-05010	50 mm ²	M10	20,0	9,0	84,0	12,8	46,0	7,0	50	3,350	-USD
TSKPBM-07012	70 mm ²	M12	20,0	11,0	84,0	12,8	46,0	7,0	50	3,350	-USD
TSKPBM-09512	95 mm ²	M12	20,0	12,5	84,0	12,8	46,0	6,3	50	3,350	-USD
TSKPBM-12012	120 mm ²	M12	25,0	13,7	107,0	12,8	62,5	13,5	30	6,000	-USD
TSKPBM-15012	150 mm ²	M12	25,0	15,5	107,0	12,8	62,5	12,2	30	6,000	-USD
TSKPBM-18512	185 mm ²	M12	32,0	17,0	117,0	14,5	64,0	20,1	20	10,000	-USD
TSKPBM-24012	240 mm ²	M12	32,0	19,5	117,0	14,5	64,0	22,6	20	10,000	-USD
TSKPBM-30012	300 mm ²	M12	36,0	23,3	157,0	16,3	90,0	33,4	15	12,000	-USD
TSKPBM-30016	300 mm ²	M16	36,0	23,3	157,0	16,3	90,0	33,4	15	12,000	-USD
TSKPBM-40016	400 mm ²	M16	36,0	26,0	157,0	16,3	90,0	30,2	9	20,000	-USD
TSKPBM-50016	500 mm ²	M16	47,0	29,0	193,0	17,0	90,0	30,2	9	40,000	-USD
TSKPBM-63016	630 mm ²	M16	47,0	32,5	193,0	17,0	90,0	30,2	6	45,000	-USD

*Diğer ölçüler için stok sorunuz..

BİMETALİK EK MUF

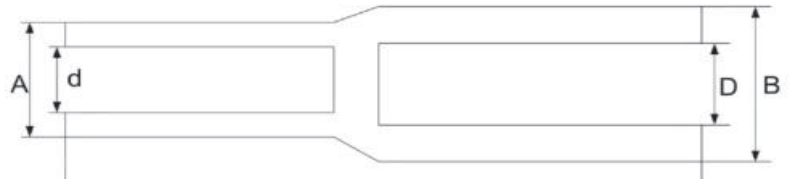

Ürün Kodu	AL Kablo Kesiti	CU Kablo Kesiti	L	Ebatlar (mm)				Ambalaj Miktarı (Ad)	Fiyat	
				A	B	d	D		USD/Adet	
TMUFB-016	16	10	70	9	10	5.7	6.5	400	1,500	-USD
TMUFB-025	25	10	75	10	12	6.5	7.5	250	1,800	-USD
TMUFB-035	35	16	84	11	14	7.5	8.5	200	2,200	-USD
TMUFB-050	50	25	89.5	12	16	8.5	10.2	150	2,900	-USD
TMUFB-070	70	35	98.5	14	18	10	11.5	100	3,400	-USD
TMUFB-095	95	50	106	16	21	11.5	13.5	50	4,800	-USD
TMUFB-120	120	70	109	18	23	13.5	15	50	6,000	-USD
TMUFB-150	150	95	116	20	25	15	16.5	40	7,700	-USD
TMUFB-185	185	120	125	22	27	16.5	18.5	25	10,700	-USD
TMUFB-240	240	150	130	24	30	18.5	21	20	11,500	-USD

*Diğer ölçüler için stok sorunuz..

VİDALI BİMETALİK KABLO PABUÇLARI

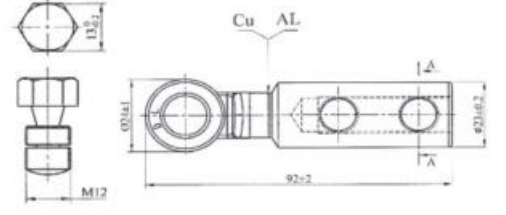

Sıkma işlemi için herhangi bir alete gerek yoktur sadece İngiliz anahtarını yada lokma anahtar yeterlidir. Tork kontrolünde kopmuş civatalar iyi bir elektriksel bağlantıyı garantiler. Sızdırmazlık macunu ile doldurulmuştur.

Malzeme : 99.9 Bakır, yüksek mukavemetli alüminyum alaşım
Uygulama : Orta gerilim

Ürün Kodu	Ürün Açıklama	Kablo Kesiti mm ²	Ebatlar (mm)			Vida	Ambalaj Miktarı (Ad)	Fiyat USD/Adet
			A	B	C			
TSKPBM VD35-150-12/2	35-150 M12 Alüminyum İki Vidalı Sıkmalı Kablo Pabucu	35/150	Ø 24 ± 1	92 ± 2	Ø 23 ± 0.2	M12 X 1,25	20	37.00 -USD
TSKPBM VD70-240-12/2	70-240 M12 Alüminyum İki Vidalı Sıkmalı Kablo Pabucu	50/150	Ø 30 ± 1	108 ± 2	Ø 28 ± 0.2	M16 X 1,25	12	48.00 -USD
TSKPBM VD120-300-12/2	120-300 M12 Alüminyum İki Vidalı Sıkmalı Kablo Pabucu	95/240	Ø 35 ± 1	129 ± 2	Ø 34 ± 0.2	M16 X 1,25	8	63.00 -USD
TSKPBM VD185-400-16/2	185-400 M16 Alüminyum İki Vidalı Sıkmalı Kablo Pabucu	185/400	Ø 50 ± 1	196 ± 3	Ø 44 ± 0.2	M22 X 1,25	3	108.00 -USD

BİMETALİK PİNLİ EKMUF

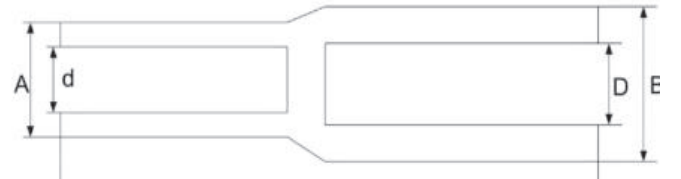

Ürün Kodu	Ürün Açıklama	Ebatlar (mm)					Ambalaj Miktarı (Ad)	Fiyat USD/Adet
		d1	D	d2	L1	L		
TMUFB-PN-010	10mm ² Bimetallik Ekmuf (Pinli)	5.5	12	5	15	58	100	2.65 -USD
TMUFB-PN-016	16mm ² Bimetallik Ekmuf (Pinli)	6.3	12	6	20	58	100	2.65 -USD
TMUFB-PN-025	25mm ² Bimetallik Ekmuf (Pinli)	7.1	12	6	20	58	100	2.75 -USD
TMUFB-PN-035	35mm ² Bimetallik Ekmuf (Pinli)	8.5	14	7	22	71	75	3.00 -USD
TMUFB-PN-050	50mm ² Bimetallik Ekmuf (Pinli)	10.0	16	8	25	74	50	3.60 -USD
TMUFB-PN-070	70mm ² Bimetallik Ekmuf (Pinli)	11.5	18	10	30	87	40	4.00 -USD
TMUFB-PN-095	95mm ² Bimetallik Ekmuf (Pinli)	13.5	22	12	33	91	20	6.00 -USD
TMUFB-PN-120	120mm ² Bimetallik Ekmuf (Pinli)	15.0	23	12	38	98	20	7.00 -USD
TMUFB-PN-150	150mm ² Bimetallik Ekmuf (Pinli)	18.5	25	12	38	108	20	7.20 -USD
TMUFB-PN-185	185mm ² Bimetallik Ekmuf (Pinli)	19	27	14	40	118	10	9.00 -USD
TMUFB-PN-240	240mm ² Bimetallik Ekmuf (Pinli)	21	32	16	40	128	8	12.00 -USD
TMUFB-PN-300	300mm ² Bimetallik Ekmuf (Pinli)	23,5	34	18	42	138	5	13.75 -USD

TRİFAZE MÜŞTEREK W OTOMAT BARALARI (İĞNE TİPİ)



Ürün Kodu	Ürün Cinsi	Bakır Kalınlığı (mm)	Boy (cm)	Modül (Ad)	Amper (A)	Ambalaj Miktarı (Ad)	Fiyat TL/Adet
TBART-1-53-63	TRİFAZE MÜŞTEREK W OTOMAT BARA 1x53	1	53	10 Grup için	63 A	25	177,000 -TL
TBART-1-106-63	TRİFAZE MÜŞTEREK W OTOMAT BARA 1x106	1	106	20 Grup için	63 A	25	354,000 -TL
TBART-1-53	TRİFAZE MÜŞTEREK W OTOMAT BARA 1x53	1	53	10 Grup için	80 A	25	225,000 -TL
TBART-1-106	TRİFAZE MÜŞTEREK W OTOMAT BARA 1x106	1	106	20 Grup için	80 A	25	450,000 -TL
TBART-1,5-53	TRİFAZE MÜŞTEREK W OTOMAT BARA 1,5x53	1,5	53	10 Grup için	80 A	25	350,000 -TL
TBART-1,5-106	TRİFAZE MÜŞTEREK W OTOMAT BARA 1,5x106	1,5	106	20 Grup için	80 A	25	700,000 -TL

*Diğer ölçüler için stok sorunuz..

MONOFOZE MÜŞTEREK W OTOMAT BARALARI (İĞNE TİPİ)



Ürün Kodu	Ürün Cinsi	Bakır Kalınlığı (mm)	Boy (cm)	Modül (Ad)	Amper	Ambalaj Miktarı (Ad)	Fiyat TL/Adet
TBARM-1-53	MONOFOZE MÜŞTEREK W OTOMAT BARA	1	53	30 Otomat için	80 A	50	79,000 -TL
TBARM-1-106	MONOFOZE MÜŞTEREK W OTOMAT BARA	1	106	60 Otomat için	80 A	50	158,000 -TL
TBARM-1,5-53	MONOFOZE MÜŞTEREK W OTOMAT BARA	1,5	53	30 Otomat için	80 A	50	122,000 -TL
TBARM-1,5-106	MONOFOZE MÜŞTEREK W OTOMAT BARA	1,5	106	60 Otomat için	80 A	50	244,000 -TL

*Diğer ölçüler için stok sorunuz..

NÖTR TOPRAKLAMA BARALARI



Ürün Kodu	Ürün Cinsi	Bakır Kalınlığı (mm)	Boy (mt)	Vida Sayısı	Ambalaj Miktarı (Ad)	Fiyat TL/Adet
TBARN-1,5-31	NÖTR TOPRAKLAMA BARASI	15mm x 1,5mm	1	31 Vida	20	280,00 -TL
TBARN-1,5-61	NÖTR TOPRAKLAMA BARASI	15mm x 1,5mm	1	61 Vida	20	330,00 -TL
TBARN-2-31	NÖTR TOPRAKLAMA BARASI	15mm x 2mm	1	31 Vida	20	400,00 -TL
TBARN-2-61	NÖTR TOPRAKLAMA BARASI	15mm x 2mm	1	61 Vida	20	425,00 -TL
TBARN-3-31	NÖTR TOPRAKLAMA BARASI	15mm x 3mm	1	31 Vida	20	585,00 -TL
TBARN-3-61	NÖTR TOPRAKLAMA BARASI	15mm x 3mm	1	61 Vida	20	610,00 -TL

DELİKLİ SAC MONTAJ RAYLARI 35X7,5



Ürün kodu	Açıklama	Uzunluk	Ambalaj Miktarı (Ad)	Fiyat TL/Adet
TDSR-1	Delikli Sac Montaj Ray 35x7,5	1 m	50	25,000 -TL
TDSR-2	Delikli Sac Montaj Ray 35x7,5	2 m	25	50,000 -TL

* Ürünlerimiz GALVANİZ KAPLAMA'dır.

* İstenilen uzunlukta üretim yapılır.

EŞ POTANSİYEL BARALAR



Ürün Kodu	Ürün Cinsi	Bakır Kalınlığı (mm)	Cıvata Sayısı (Ad)	Boy (cm)	Ambalaj Miktarı (Ad)	Fiyat TL/Adet
TEPB-2105303	21 CM 5 CİVATA EŞPOTANSİYEL BARA (30X3)	30x3	5	21	1	17,00 -USD
TEPB-2105405	30 CM 7 CİVATA EŞPOTANSİYEL BARA (30X3)	30x3	7	30	1	21,50 -USD
TEPB-2510303	21 CM 5 CİVATA EŞPOTANSİYEL BARA (30X5)	30X5	5	21	1	24,50 -USD
TEPB-3007303	30 CM 7 CİVATA EŞPOTANSİYEL BARA (30X5)	30X5	7	30	1	31,50 -USD
TEPB-3007305	40 CM 9 CİVATA EŞPOTANSİYEL BARA (30X5)	30X5	9	40	1	41,00 -USD
TEPB-3007405	50 CM 12 CİVATA EŞPOTANSİYEL BARA (30X5)	30X5	12	50	1	49,00 -USD
TEPB-4009305	21 CM 5 CİVATA EŞPOTANSİYEL BARA (40X5)	40x5	5	21	1	29,00 -USD
TEPB-4009405	30 CM 7 CİVATA EŞPOTANSİYEL BARA (40X5)	40x5	7	30	1	41,00 -USD
TEPB-5012305	40 CM 9 CİVATA EŞPOTANSİYEL BARA (40X5)	40x5	9	40	1	52,00 -USD
TEPB-5012405	50 CM 12 CİVATA EŞPOTANSİYEL BARA (40X5)	40x5	12	50	1	63,00 -USD

NÖTR BARA MESNEDİ



Ürün Kodu	Ürün Cinsi	Ambalaj Miktarı (Ad)	Fiyat TL/Adet
TBARN-M	Nötr bara mesnedi	150	14,00 -TL

SAC RAY TAŞIYICI

Ürün kodu	Açıklama	Ambalaj Miktarı (Ad)	Fiyat TL/Adet
TSRT	Sac Ray Taşıyıcı	100	0,55 -USD



“maximum enerji maximum **TORK®**”

İZOLELİ KABLO YÜKSÜKLERİ

İZOLELİ KABLO YÜKSÜKLERİ - FRANSIZ NORMU DIN 46228



Malzeme : Bakır (E-Cu)
İzolasyon : PA66 Naylon
Çalışma Sıcaklığı : Maksimum 105° 1000 Volt

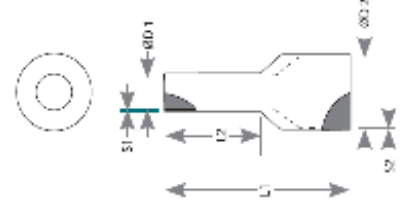

Ürün Kodu	Kablo Kesiti mm ²	Renk	D1	D2	L1	L2	Ambalaj Miktarı (Ad)	Fiyat TL/Adet
TYIF-0,50	0,50	Beyaz	1,00	2,60	14,00	8,00	1.000	0,125 -TL
TYIF-0,75	0,75	Mavi	1,20	2,80	14,00	8,00	1.000	0,125 -TL
TYIF-1,0	1,00	Kırmızı	1,40	3,00	14,00	8,00	1.000	0,125 -TL
TYIF-1,5	1,50	Siyah	1,70	3,50	14,00	8,00	1.000	0,140 -TL
TYIF-2,5	2,50	Gri	2,20	4,20	14,00	8,00	500	0,175 -TL
TYIF-4,0	4,00	Turuncu	2,80	4,80	17,00	10,00	500	0,300 -TL
TYIF-6,0	6,00	Yeşil	3,50	6,30	20,00	12,00	250	0,400 -TL
TYIF-10	10,00	Kahverengi	4,50	7,60	22,00	12,00	100	0,500 -TL
TYIF-16	16,00	Fildişi	5,80	8,80	24,00	12,00	100	0,700 -TL
TYIF-25	25,00	Siyah	7,30	11,20	30,00	16,00	50	1,260 -TL
TYIF-35	35,00	Kırmızı	8,30	12,70	30,00	16,00	50	1,520 -TL
TYIF-50	50,00	Mavi	10,20	15,00	36,00	20,00	25	3,050 -TL

İZOLELİ KABLO YÜKSÜKLERİ - ALMAN NORMU DIN 46228



Malzeme : Bakır (E-Cu)
İzolasyon : PA66 Naylon
Çalışma Sıcaklığı : Maksimum 105° 1000 Volt

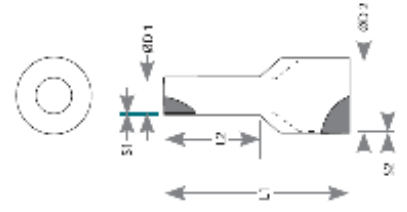

Ürün Kodu	Kablo Kesiti mm ²	Renk	D1	D2	L1	L2	Ambalaj Miktarı (Ad)	Fiyat TL/Adet
TYIA-0,50	0,50	Turuncu	1,00	2,60	14,00	8,00	1.000	0,125 -TL
TYIA-0,75	0,75	Beyaz	1,20	2,80	14,00	8,00	1.000	0,125 -TL
TYIA-1,0	1,00	Sarı	1,40	3,00	14,00	8,00	1.000	0,125 -TL
TYIA-1,5	1,50	Kırmızı	1,70	3,50	14,00	8,00	1.000	0,140 -TL
TYIA-2,5	2,50	Mavi	2,20	4,20	14,00	8,00	500	0,175 -TL
TYIA-4,0	4,00	Gri	2,80	4,80	17,00	10,00	500	0,300 -TL
TYIA-6,0	6,00	Siyah	3,50	6,30	20,00	12,00	250	0,400 -TL
TYIA-10	10,00	Fildişi	4,50	7,60	22,00	12,00	100	0,500 -TL
TYIA-16	16,00	Yeşil	5,80	8,80	24,00	12,00	100	0,700 -TL
TYIA-25	25,00	Kahverengi	7,30	11,20	30,00	16,00	50	1,260 -TL
TYIA-35	35,00	Fildişi	8,30	12,70	30,00	16,00	50	1,520 -TL
TYIA-50	50,00	Yeşil	10,20	15,00	36,00	20,00	25	3,050 -TL

İZOLELİ ÇİFT GİRİŞLİ KABLO YÜKSÜKLERİ FRANSIZ NORMU DIN 46228



Malzeme : Bakır (E-Cu)
İzolasyon : PAG6 Naylon
Çalışma Sıcaklığı : Maksimum 105° 1000 Volt

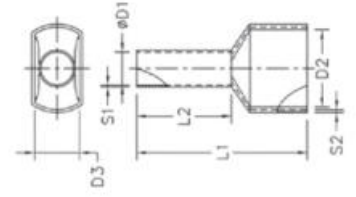

Ürün Kodu	Kablo Kesiti mm ²	Renk	D1	W	W1	L1	L2	Ambalaj Miktarı (Ad)	Fiyat TL/Adet
TYÇF-0,50	2 x 0,50	Beyaz	1,50	2,70	4,70	15,00	8,00	1.000	0,250 -TL
TYÇF-0,75	2 x 0,75	Mavi	1,80	2,80	5,00	15,00	8,00	500	0,260 -TL
TYÇF-1,0	2 x 1,00	Kırmızı	2,05	3,40	5,40	15,00	8,00	500	0,290 -TL
TYÇF-1,5	2 x 1,50	Siyah	2,30	3,60	6,60	16,00	8,00	400	0,350 -TL
TYÇF-2,5	2 x 2,50	Gri	2,80	4,20	7,80	18,50	10,00	250	0,540 -TL
TYÇF-4,0	2 x 4,00	Turuncu	3,70	4,90	8,80	23,00	12,00	200	0,630 -TL
TYÇF-6,0	2 x 6,00	Yeşil	4,80	6,90	10,00	26,00	14,00	100	0,850 -TL
TYÇF-10	2 x 10,00	Kahverengi	6,40	7,60	12,80	26,50	14,00	50	1,200 -TL
TYÇF-16	2 x 16,00	Fildişi	8,30	9,60	18,60	31,50	14,00	25	1,700 -TL

İZOLELİ ÇİFT GİRİŞLİ KABLO YÜKSÜKLERİ ALMAN NORMU DIN 46228



Malzeme : Bakır (E-Cu)
İzolasyon : PAG6 Naylon
Çalışma Sıcaklığı : Maksimum 105° 1000 Volt

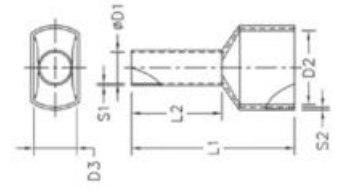

Ürün Kodu	Kablo Kesiti mm ²	Renk	D1	W	W1	L1	L2	Ambalaj Miktarı (Ad)	Fiyat TL/Adet
TYÇA-0,50	2 x 0,50	Turuncu	1,50	2,70	4,70	15,00	8,00	1.000	0,250 -TL
TYÇA-0,75	2 x 0,75	Beyaz	1,80	2,80	5,00	15,00	8,00	500	0,260 -TL
TYÇA-1,0	2 x 1,00	Sarı	2,05	3,40	5,40	15,00	8,00	500	0,290 -TL
TYÇA-1,5	2 x 1,50	Kırmızı	2,30	3,60	6,60	16,00	8,00	400	0,350 -TL
TYÇA-2,5	2 x 2,50	Mavi	2,80	4,20	7,80	18,50	10,00	250	0,540 -TL
TYÇA-4,0	2 x 4,00	Gri	3,70	4,90	8,80	23,00	12,00	200	0,630 -TL
TYÇA-6,0	2 x 6,00	Siyah	4,80	6,90	10,00	26,00	14,00	100	0,850 -TL
TYÇA-10	2 x 10,00	Fildişi	6,40	7,60	12,80	26,50	14,00	50	1,200 -TL
TYÇA-16	2 x 16,00	Yeşil	8,30	9,60	18,60	31,50	14,00	25	1,700 -TL

YUVARLAK TİP İZOLELİ KABLO UÇLARI

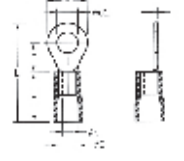

Malzeme : Bakır (E-Cu), Kalay kaplı
İzolasyon : PVC
Çalışma Sıcaklığı : Maksimum 75° 600 Volt

Ürün Kodu	Kablo Kesiti mm ²	Renk	Cıvata Ölçüsü	d2	B	F	L	H	d	D	T	Ambalaj Miktarı (Ad)	Fiyat TL/Adet
TPY-301	0,50-1,50	Kırmızı	M3	3,2	5,5	4,8	17,5	10,0	1,7	4,2	0,8	200	0,470 -TL
TPY-401		Kırmızı	M4	4,3	8,0	7,0	21,0					200	0,660 -TL
TPY-501		Kırmızı	M5	5,3	8,0	7,0	21,0					200	0,670 -TL
TPY-601		Kırmızı	M6	6,4	11,6	11,1	26,9					200	1,000 -TL
TPY-801		Kırmızı	M8	8,4	11,6	11,1	26,9					200	1,050 -TL
TPY-302	1,50-2,50	Mavi	M3	3,2	6,6	4,3	17,6	10,0	2,3	4,6	0,8	200	0,800 -TL
TPY-402		Mavi	M4	4,3	6,6	6,3	19,6					200	0,800 -TL
TPY-502		Mavi	M5	5,3	8,5	7,8	22,0					200	0,820 -TL
TPY-602		Mavi	M6	6,4	12,0	11,0	27,0					200	1,150 -TL
TPY-802		Mavi	M8	8,4	12,0	11,0	27,0					200	1,150 -TL
TPY-406	4,00-6,00	Sarı	M4	4,3	7,2	5,9	22,5	13,0	3,4	6,5	1,0	100	1,700 -TL
TPY-506		Sarı	M5	5,3	9,5	8,3	26,0					100	1,700 -TL
TPY-606		Sarı	M6	6,4	12,0	10,5	29,5					100	1,950 -TL
TPY-806		Sarı	M8	8,4	15,0	13,7	34,2					100	2,400 -TL
TPY-1006		Sarı	M10	10,5	15,0	13,7	34,2					100	2,500 -TL
TPY-1206		Sarı	M12	13,0	19,2	16,0	38,6					100	2,550 -TL

ÇATAL TİP İZOLELİ KABLO UÇLARI

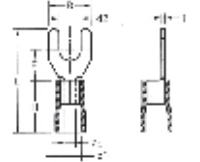

Malzeme : Bakır (E-Cu), Kalay kaplı
İzolasyon : PVC
Çalışma Sıcaklığı : Maksimum 75° 600 Volt

Ürün Kodu	Kablo Kesiti mm ²	Renk	Cıvata Ölçüsü	d2	B	F	L	H	d	D	T	Ambalaj Miktarı (Ad)	Fiyat TL/Adet
TPÇ-3001	0,50-1,50	Kırmızı	M3	3,2	5,8	6,3	21,0	10,0	1,7	4,2	0,8	200	0,580 -TL
TPÇ-4001		Kırmızı	M4	4,3	6,4	6,3	6,3					200	0,590 -TL
TPÇ-5001		Kırmızı	M5	5,3	8,1	7,0	21,7					200	0,610 -TL
TPÇ-6001		Kırmızı	M6	6,4	9,5	7,0	21,0					200	0,660 -TL
TPÇ-3002		1,50-2,50	Mavi	M3	3,2	5,8	6,5					21,2	21,0
TPÇ-4002	Mavi		M4	4,3	6,4	6,5	21,2	200	0,660 -TL				
TPÇ-5002	Mavi		M5	5,3	9,5	7,0	21,7	200	0,670 -TL				
TPÇ-6002	Mavi		M6	6,4	12,0	11,0	27,4	200	0,900 -TL				
TPÇ-4006	4,00-6,00		Sarı	M4	4,3	8,3	7,5	26,0	13,0	3,4	6,6	1,1	
TPÇ-5006		Sarı	M5	5,3	9,5	7,5	25,7	100					1,500 -TL
TPÇ-6006		Sarı	M6	6,4	12,0	12,0	31,7	100					1,900 -TL
TPÇ-8006		Sarı	M8	8,4	13,5	12,2	31,7	100					2,300 -TL

DIŐI FASTON TİP İZOLELİ KABLO UÇLARI



Malzeme : Bakır Yüksüklü, Kalay Kaplı
İzolasyon : PVC
Çalışma Sıcaklığı : Maksimum 75° 600 Volt

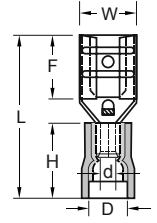

Ürün Kodu	Kablo Kesiti mm ²	Renk	W	F	L	H	d	D	T	Ambalaj Miktarı (Ad)	Fiyat TL/Adet
TPFD-1288	0,50-1,50	Kırmızı	3,2	6,4	18,9	10,5	1,7	4,1	0,8	200	0,480 -TL
TPFD-1488		Kırmızı	5	6,4	19,5					200	0,580 -TL
TPFD-1638		Kırmızı	6,6	7,8	21,5					200	0,720 -TL
TPFD-2288	1,50-2,50	Mavi	3,2	6,4	18,9	10,5	2,3	4,9	0,8	200	0,580 -TL
TPFD-2488		Mavi	5	6,4	19,5					200	0,630 -TL
TPFD-2638		Mavi	6,6	7,8	21,5					200	0,730 -TL
TPFD-5638	4,00-6,00	Sarı	6,6	7,8	24,0	13,0	3,4	6,7	0,8	100	0,870 -TL

TAM İZOLELİ DIŐI FASTON TİP KABLO UÇLARI



Malzeme : Prınc, Kalay Kaplı, Bakır Yüksüklü
İzolasyon : PVC
Çalışma Sıcaklığı : Maksimum 75° 600 Volt

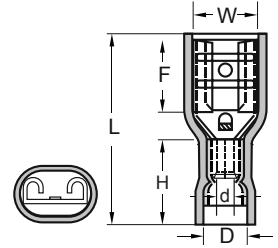

Ürün Kodu	Kablo Kesiti mm ²	Renk	W	F	L	H	d	D	T	Ambalaj Miktarı (Ad)	Fiyat TL/Adet
TPFFD-1288	0,50-1,50	Kırmızı	3,2	6,4	19,4	10,5	1,7	4,1	0,8	200	0,650 -TL
TPFFD-1488		Kırmızı	5	6,4	20,0					200	0,730 -TL
TPFFD-1638		Kırmızı	6,6	7,8	22,0					100	0,960 -TL
TPFFD-2288	1,50-2,50	Mavi	3,2	6,4	19,4	10,5	2,3	4,9	0,8	200	0,740 -TL
TPFFD-2488		Mavi	5	6,4	20,0					200	0,760 -TL
TPFFD-2638		Mavi	6,6	7,8	22,0					100	0,960 -TL
TPFFD-5638	4,00-6,00	Sarı	6,6	7,8	24,5	13,0	3,4	6,7	0,8	100	1,100 -TL

İZOLELİ EKMUFLAR



Malzeme : Bakır (E-Cu), Kalay Kaplı
Standart : DIN 46237
İzolasyon : PVC
Çalışma Sıcaklığı : Maksimum 75° 600 Volt

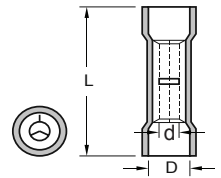

Ürün Kodu	Kablo Kesiti mm ²	Renk	L	d	D	Ambalaj Miktarı (Ad)	Fiyat TL/Adet
TPBY-251	0,50-1,50	Kırmızı	26,0	1,7	4,1	200	0,870 -TL
TPBY-252	1,50-2,50	Mavi	26,0	2,3	4,5	200	1,000 -TL
TPBY-256	4,00-6,00	Sarı	26,0	3,4	6,3	100	1,480 -TL

KURŞUN DIŞİ TERMİNALLER (Ekstra Bakır Yüksüklü)



Malzeme : Pring, Kalay Kaplı, Bakır Yüksüklü
İzolasyon : PVC
Çalışma Sıcaklığı : Maksimum 75° 600 Volt

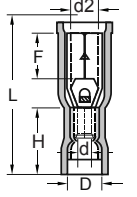

Ürün Kodu	Kablo Kesiti mm ²	Renk	d2	F	L	H	d	D	Ambalaj Miktarı (Ad)	Fiyat TL/Adet
TPBD-1040	0,50-1,50	Kırmızı	3,9	8,7	22,5	10,5	1,7	4,1	200	1,450 -TL
TPBD-2040	1,50-2,50	Mavi	3,9	8,7	22,5	10,5	2,3	4,9	200	1,620 -TL
TPBD-2050		Mavi	4,9	8,8	22,5	10,5	2,3	4,9	100	1,620 -TL
TPBD-5050	4,00-6,00	Sarı	4,9	8,8	25,0	13,0	3,4	6,7	100	2,000 -TL

KURŞUN ERKEK TERMİNALLER (Ekstra Bakır Yüksüklü)



Malzeme : Pring, Kalay Kaplı, Bakır Yüksüklü
İzolasyon : PVC
Çalışma Sıcaklığı : Maksimum 75° 600 Volt

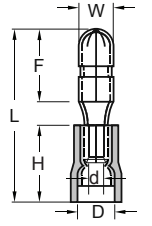

Ürün Kodu	Kablo Kesiti mm ²	Renk	d2	F	L	H	d	D	Ambalaj Miktarı (Ad)	Fiyat TL/Adet
TPBE-1040	0,50-1,50	Kırmızı	4	8,7	21,5	10,5	1,7	4,1	200	1,200 -TL
TPBE-2040	1,50-2,50	Mavi	4	8,7	21,5	10,5	2,3	4,9	200	1,600 -TL
TPBE-2050		Mavi	5	8,9	21,5	10,5	2,3	4,9	200	1,600 -TL
TPBE-5050	4,00-6,00	Sarı	5	8,9	24,0	13,0	3,4	6,7	100	1,800 -TL

TAM İZOLELİ NAYLON BAYRAK TİP TERMİNALLER



Malzeme : Pring, Kalay Kaplı, Bakır Yüksüklü
İzolasyon : Naylon
Çalışma Sıcaklığı : Maksimum 105° 600 Volt

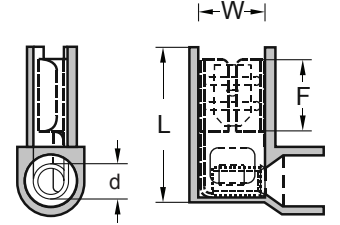

Ürün Kodu	Kablo Kesiti mm ²	Renk	W	F	L	H	d	D	T	Ambalaj Miktarı (Ad)	Fiyat TL/Adet
TPFDEB-1861	0,50-1,50	Kırmızı	6,6	7,8	21,5	10,5	1,7	4,0	0,8	100	1,35 -TL
TPFDEB-2862	1,50-2,50	Mavi	6,6	7,8	21,5	10,5	2,3	4,9	0,8	100	1,35 -TL

ERKEK/DİŞİ GERİ DÖNÜŞLÜ TERMİNALLER



Malzeme : Pring, Kalay Kaplı, Bakır Yüksüklü
İzolasyon : PVC
Çalışma Sıcaklığı : Maksimum 75° 600 Volt

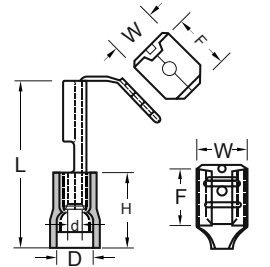

Ürün Kodu	Kablo Kesiti mm ²	Renk	W	F	L	H	d	D	T	Ambalaj Miktarı (Ad)	Fiyat TL/Adet
TPFDEG-1861	0,50-1,50	Kırmızı	6,6	7,8	21,5	10,5	1,7	4,0	0,8	100	1,100 -TL
TPFDEG-2862	1,50-2,50	Mavi	6,6	7,8	21,5	10,5	2,3	4,9	0,8	100	1,100 -TL
TPFDEG-5866	4,00-6,00	Sarı	6,6	7,8	24,0	13,0	-	6,2	0,8	100	1,250 -TL

İĞNE TİP İZOLELİ KABLO UÇLARI



Malzeme : Bakır (E-Cu), Kalay kaplı
İzolasyon : PVC
Çalışma Sıcaklığı : Maksimum 75° 600 Volt

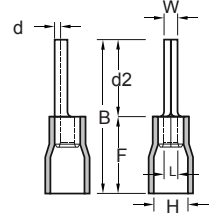

Ürün Kodu	Kablo Kesiti mm ²	Renk	W	d2	B	F	L	H	d	Ambalaj Miktarı (Ad)	Fiyat TL/Adet
TPI-101	0,50-1,50	Kırmızı	1,9	10,0	20,0	10,0	1,7	4,2	0,8	200	0,690 -TL
TPI-102	1,50-2,50	Mavi	1,9	10,0	20,0	10,0	2,3	4,6	0,8	200	0,820 -TL
TPI-106	4,00-6,00	Sarı	2,7	14,0	27,0	13,0	3,4	6,6	1,0	100	1,950 -TL

ERKEK FASTON TİP TERMİNALLER (Ekstra Bakır Yüksüklü)



Malzeme : Prınc, Kalay Kaplı, Bakır Yüksüklü
İzolasyon : PVC
Çalışma Sıcaklığı : Maksimum 75° 600 Volt

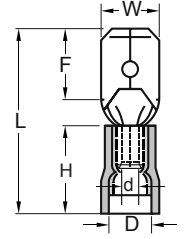

Ürün Kodu	Kablo Kesiti mm ²	Renk	W	F	L	H	d	D	T	Ambalaj Miktarı (Ad)	Fiyat TL/Adet
TPFE-1288	0,50-1,50	Kırmızı	2,8	6,6	19,3	10,5	1,7	4,1	0,8	200	0,450 -TL
TPFE-1488		Kırmızı	4,8	6,6	19,3					200	0,450 -TL
TPFE-1638		Kırmızı	6,3	7,8	21,5					200	0,530 -TL
TPFE-2288	1,50-2,50	Mavi	2,8	6,6	19,3	10,5	2,3	5,0	0,8	200	0,450 -TL
TPFE-2488		Mavi	4,8	6,6	19,3					200	0,450 -TL
TPFE-2638		Mavi	6,3	7,8	21,5					200	0,580 -TL
TPFE-5638	4,00-6,00	Sarı	6,3	7,8	24,0	13,0	3,4	6,7	0,8	100	0,680 -TL

İZOLESİZ KABLO YÜKSÜKLERİ DIN 46228



Malzeme : Bakır (E-Cu), Kalay kaplı

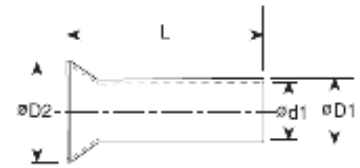

Ürün Kodu	Kablo Kesiti mm ²	D1	D2	L	Ambalaj Miktarı (Ad)	Fiyat TL/Adet
TY-0,50	0,50	1	2,10	10,00	2.000	0,115 -TL
TY-0,75	0,75	1,2	2,30	10,00	2.000	0,115 -TL
TY-1,0	1,00	1,4	2,50	10,00	2.000	0,115 -TL
TY-1,5	1,50	1,7	2,80	10,00	2.000	0,125 -TL
TY-2,5	2,50	2,2	3,40	12,00	2.000	0,170 -TL
TY-4,0	4,00	2,8	4,00	12,00	1.000	0,230 -TL
TY-6,0	6,00	3,5	4,70	12,00	500	0,320 -TL
TY-10	10,00	4,5	5,80	15,00	200	0,530 -TL
TY-16	16,00	5,8	7,50	15,00	200	0,650 -TL
TY-25	25,00	7,3	9,50	16,00	100	1,000 -TL
TY-35	35,00	8,3	11,00	16,00	100	1,100 -TL
TY-50	50,00	10,3	13,00	20,00	25	2,300 -TL

"maximum enerji maximum **TORK**"



Ø 22 MM LED SİNYALLER



Ürün Kodu	Ürün Cinsi	Renk	Voltaj	Ambalaj Miktarı (Ad)	Koli Miktarı (Ad)	Fiyat TL/Adet
AD16DS-220K	Ø22 LED SİNYAL 220V AC (KIRMIZI)		220V AC/DC	10	500	14,600 -TL
AD16DS-220Y	Ø22 LED SİNYAL 220V AC (YEŞİL)		220V AC/DC	10	500	14,600 -TL
AD16DS-220S	Ø22 LED SİNYAL 220V AC (SARI)		220V AC/DC	10	500	14,600 -TL
AD16DS-220M	Ø22 LED SİNYAL 220V AC (MAVİ)		220V AC/DC	10	500	14,600 -TL
AD16DS-220B	Ø22 LED SİNYAL 220V AC (BEYAZ)		220V AC/DC	10	500	18,130 -TL
AD16DS-110K	Ø22 LED SİNYAL 110V AC/DC (KIRMIZI)		110V AC/DC	10	500	14,600 -TL
AD16DS-110Y	Ø22 LED SİNYAL 110V AC/DC (YEŞİL)		110V AC/DC	10	500	14,600 -TL
AD16DS-110S	Ø22 LED SİNYAL 110V AC/DC (SARI)		110V AC/DC	10	500	14,600 -TL
AD16DS-110M	Ø22 LED SİNYAL 110V AC/DC (MAVİ)		110V AC/DC	10	500	14,600 -TL
AD16DS-110B	Ø22 LED SİNYAL 110V AC/DC (BEYAZ)		110V AC/DC	10	500	18,130 -TL
AD16DS-24K	Ø22 LED SİNYAL 24V AC/DC (KIRMIZI)		24V AC/DC	10	500	14,600 -TL
AD16DS-24Y	Ø22 LED SİNYAL 24V AC/DC (YEŞİL)		24V AC/DC	10	500	14,600 -TL
AD16DS-24S	Ø22 LED SİNYAL 24V AC/DC (SARI)		24V AC/DC	10	500	14,600 -TL
AD16DS-24M	Ø22 LED SİNYAL 24V AC/DC (MAVİ)		24V AC/DC	10	500	14,600 -TL
AD16DS-24B	Ø22 LED SİNYAL 24V AC/DC (BEYAZ)		24V AC/DC	10	500	18,130 -TL

BA9S LED AMPULLER



Ürün Kodu	Ürün Cinsi	Renk	Voltaj	Ambalaj Miktarı (Ad)	Koli Miktarı (Ad)	Fiyat TL/Adet
BA9SC-K	LED AMPUL		220V AC/DC	50	4000	19,000 -TL
BA9SC-Y			220V AC/DC	50	4000	19,000 -TL
BA9SC-S			220V AC/DC	50	4000	19,000 -TL
BA9SC-M			220V AC/DC	50	4000	19,000 -TL
BA9SC-B			220V AC/DC	50	4000	23,000 -TL
BA9SC-110-K	LED AMPUL		110V AC/DC	50	4000	19,000 -TL
BA9SC-110-Y			110V AC/DC	50	4000	19,000 -TL
BA9SC-110-S			110V AC/DC	50	4000	19,000 -TL
BA9SC-110-M			110V AC/DC	50	4000	19,000 -TL
BA9SC-110-B			110V AC/DC	50	4000	23,000 -TL
BA9SC-24-K	LED AMPUL		24V AC/DC	50	4000	19,000 -TL
BA9SC-24-Y			24V AC/DC	50	4000	19,000 -TL
BA9SC-24-S			24V AC/DC	50	4000	19,000 -TL
BA9SC-24-M			24V AC/DC	50	4000	19,000 -TL
BA9SC-24-B			24V AC/DC	50	4000	23,000 -TL

Ø 22 MM VOLTMETRE

Ürün Kodu	Ürün Cinsi	Çap mm	Renk	Ambalaj Miktarı (Ad)	Koli Miktarı (Ad)	Fiyat TL/Adet
AD116DSV-K	VOLTMETRE 24-500V (KIRMIZI)	22		10	500	63,000 -TL
AD116DSV-Y	VOLTMETRE 24-500V (YEŞİL)	22		10	500	63,000 -TL
AD116DSV-S	VOLTMETRE 24-500V (SARI)	22		10	500	63,000 -TL
AD116DSV-M	VOLTMETRE 24-500V (MAVİ)	22		10	500	63,000 -TL
AD116DSV-B	VOLTMETRE 24-500V (BEYAZ)	22		10	500	63,000 -TL



Ø 22 MM AMPERMETRE

Ürün Kodu	Ürün Cinsi	Amper	Çap mm	Renk	Ambalaj Miktarı (Ad)	Koli Miktarı (Ad)	Fiyat TL/Adet
AD116DSA-K	AMPERMETRE (KIRMIZI)	100A	22		5	300	118,000 -TL
AD116DSA-Y	AMPERMETRE (YEŞİL)	100A	22		5	300	118,000 -TL
AD116DSA-S	AMPERMETRE (SARI)	100A	22		5	300	118,000 -TL
AD116DSA-M	AMPERMETRE (MAVİ)	100A	22		5	300	118,000 -TL
AD116DSA-B	AMPERMETRE (BEYAZ)	100A	22		5	300	118,000 -TL



Ø 22 MM VOLTAMPERMETRE

Ürün Kodu	Ürün Cinsi	Amper	Çap mm	Renk	Ambalaj Miktarı (Ad)	Koli Miktarı (Ad)	Fiyat TL/Adet
AD116DSVA-K	VOLTAMPERMETRE (KIRMIZI)	24-500 VAC 1A 100A AC Akım Trafolu	22		5	500	155,000 -TL
AD116DSVA-Y	VOLTAMPERMETRE (YEŞİL)	24-500 VAC 1A 100A AC Akım Trafolu	22		5	500	155,000 -TL
AD116DSVA-S	VOLTAMPERMETRE (SARI)	24-500 VAC 1A 100A AC Akım Trafolu	22		5	250	155,000 -TL
AD116DSVA-M	VOLTAMPERMETRE (MAVİ)	24-500 VAC 1A 100A AC Akım Trafolu	22		5	250	155,000 -TL
AD116DSVA-B	VOLTAMPERMETRE (BEYAZ)	24-500 VAC 1A 100A AC Akım Trafolu	22		5	500	155,000 -TL



Ø 22 MM LEDLİ BUZZER (90dB)

Ürün Kodu	Ürün Cinsi	Renk & işaret	Voltaj	Ambalaj Miktarı (Ad)	Koli Miktarı (Ad)	Fiyat TL/Adet
AD16SM-220K	Ø22 SESLİ LED FLASÖR İKAZLI 220V AC (KIRMIZI)		220V AC	10	500	58,000 -TL
AD16SM-24K	Ø22 SESLİ LED FLASÖR İKAZLI 24V AC/DC (KIRMIZI)		24V AC/DC	10	500	58,000 -TL



Ø 22 MM YAYLI BUTONLAR



Ürün Kodu	Ürün Cinsi	Renk	Kutu Miktarı (Ad)	Fiyat TL/Adet
TRK-A5-10	NO1 START YAYLI BUTON (YEŞİL)		10	40,000 -TL
TRK-A5-11	NO1 START YAYLI BUTON (SARI)		10	40,000 -TL
TRK-A5-21	NO1 START YAYLI BUTON (MAVİ)		10	40,000 -TL
TRK-A5-31	NO1 START YAYLI BUTON (BEYAZ)		10	40,000 -TL
TRK-A5-41	NC1 START YAYLI BUTON (SİYAH)		10	40,000 -TL
TRK-A5-01	NC1 STOP YAYLI BUTON (KIRMIZI)		10	40,000 -TL

İŞARETLİ YAYLI BUTONLAR



Ürün Kodu	Ürün Cinsi	İşaret	Kutu Miktarı (Ad)	Fiyat TL/Adet
TRK-A5-10/1	NO1 START İŞARETLİ YAYLI BUTON (YEŞİL)		10	45,500 -TL
TRK-A5-01/2	NO1 START İŞARETLİ YAYLI BUTON (BEYAZ)		10	45,500 -TL
TRK-A5-10/3	NO1 START İŞARETLİ YAYLI BUTON (SİYAH)		10	45,500 -TL
TRK-A5-10/2	NC1 STOP İŞARETLİ YAYLI BUTON (KIRMIZI)		10	45,500 -TL

LED İŞIKLI YAYLI BUTONLAR



Ürün Kodu	Ürün Cinsi	Renk	Kutu Miktarı (Ad)	Fiyat TL/Adet
TRK-A5-10D	NO1		10	72,500 -TL
TRK-A5-11D	NO1		10	72,500 -TL
TRK-A5-21D	NO1		10	72,500 -TL
TRK-A5-31D	NO1		10	72,500 -TL
TRK-A5-01D	NO1		10	72,500 -TL
TRK-A5-10D-110	NO1		10	72,500 -TL
TRK-A5-11D-110	NO1		10	72,500 -TL
TRK-A5-21D-110	NO1		10	72,500 -TL
TRK-A5-31D-110	NO1		10	72,500 -TL
TRK-A5-01D-110	NC1		10	72,500 -TL
TRK-A5-10D-24	NO1		10	72,500 -TL
TRK-A5-11D-24	NO1		10	72,500 -TL
TRK-A5-21D-24	NO1		10	72,500 -TL
TRK-A5-31D-24	NO1		10	72,500 -TL
TRK-A5-01D-24	NC1		10	72,500 -TL

Ø 22 MM KALICI MANDAL BUTONLAR



Ürün Kodu	Ürün Cinsi	Pozisyon	Kutu Miktarı (Ad)	Fiyat TL/Adet
TRK-A5-10X	NO1 KALICI MANDAL BUTON	0-1	10	44,500 -TL
TRK-A5-20XS	NO2 KALICI MANDAL BUTON	1-0-2	10	58,500 -TL

Ø 22 MM KAYICI MANDAL BUTONLAR

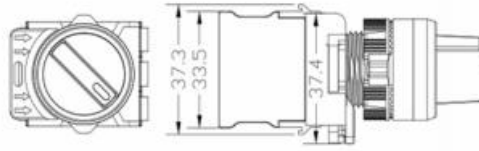

Ürün Kodu	Ürün Cinsi	Çap mm	Pozisyon	Kutu Miktarı (Ad)	Fiyat TL/Adet
TRK-A3-10X/FU	NO1 KAYICI MANDAL BUTON	22	0-1	10	47,000 -TL
TRK-A3-20XS/FFU	NO2 KAYICI MANDAL BUTON	22	1-0-2	10	60,000 -TL

Ø 22 MM KALICI-KAYICI MANDAL BUTONLAR

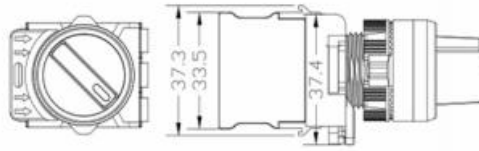

Ürün Kodu	Ürün Cinsi	Çap mm	Pozisyon	Kutu Miktarı (Ad)	Fiyat TL/Adet
TRK-A3-20XS/F	NO2 KALICI/KAYICI MANDAL BUTON (Sağ Dönüş Kalıcı - Sol Dönüş Kayıcı)	22	1-0-2	10	64,000 -TL

Ø 22 MM ANAHTARLI KALICI BUTONLAR

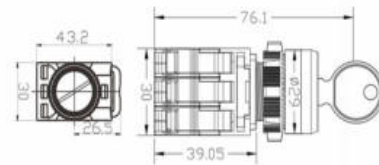

Ürün Kodu	Ürün Cinsi	Çap mm	Pozisyon	Kutu Miktarı (Ad)	Fiyat TL/Adet
TRK-A3-10Y	NO1 ANAHTARLI BUTON	22	0-1	10	70,000 -TL
TRK-A3-20YS	NO2 ANAHTARLI BUTON	22	1-0-2	10	86,000 -TL

Ø 22 MM IŞIKLI KALICI MANDAL BUTONLAR



Ürün Kodu	Ürün Cinsi	Renk	Pozisyon	Kutu Miktarı (Ad)	Fiyat TL/Adet
TRK-A5-10XD NO1	IŞIKLI KALICI MANTAR BUTON 220V AC/DC	Yeşil	0-1	10	74,000 -TL
TRK-A5-11XD NO1		Sarı	0-1	10	74,000 -TL
TRK-A5-01XD NC1		Kırmızı	0-1	10	74,000 -TL
TRK-A5-10XD-110 NO1	IŞIKLI KALICI MANTAR BUTON 110V AC/DC	Yeşil	0-1	10	74,000 -TL
TRK-A5-11XD-110 NO1		Sarı	0-1	10	74,000 -TL
TRK-A5-01XD-110 NC1		Kırmızı	0-1	10	74,000 -TL
TRK-A5-10XD-24 NO1	IŞIKLI KALICI MANTAR BUTON 24V AC/DC	Yeşil	0-1	10	74,000 -TL
TRK-A5-11XD-24 NO1		Sarı	0-1	10	74,000 -TL
TRK-A5-01XD-24 NC1		Kırmızı	0-1	10	74,000 -TL
TRK-A5-20XSD NO2	IŞIKLI KALICI MANTAR BUTON 220V AC/DC	Yeşil	1-0-2	10	74,000 -TL
TRK-A5-21XSD NO2		Sarı	1-0-2	10	74,000 -TL
TRK-A5-02XSD NC2		Kırmızı	1-0-2	10	74,000 -TL
TRK-A5-20XSD-110 NO2	IŞIKLI KALICI MANTAR BUTON 110V AC/DC	Yeşil	1-0-2	10	74,000 -TL
TRK-A5-21XSD-110 NO2		Sarı	1-0-2	10	74,000 -TL
TRK-A5-02XSD-110 NC2		Kırmızı	1-0-2	10	74,000 -TL
TRK-A5-20XSD-24 NO2	IŞIKLI KALICI MANTAR BUTON 24V AC/DC	Yeşil	1-0-2	10	74,000 -TL
TRK-A5-21XSD-24 NO2		Sarı	1-0-2	10	74,000 -TL
TRK-A5-02XSD-24 NC2		Kırmızı	1-0-2	10	74,000 -TL

Ø 40 MM KALICI MANTAR BUTON (ACİL STOP)



Ürün Kodu	Ürün Cinsi	Renk	Kutu Miktarı (Ad)	Fiyat TL/Adet
TRK-A3-01ZS	NC1 STOP MANTAR BUTON KIRMIZI	Kırmızı	10	50,000 -TL

Ø 40 MM KALICI MANTAR LED IŞIKLI BUTONLAR



Ürün Kodu	Ürün Cinsi	Renk	Kutu Miktarı (Ad)	Fiyat TL/Adet
TRK-A1-01ZSD	NC1 LED IŞIKLI STOP MANTAR BUTON 220V AC/DC	STOP	10	105,000 -TL
TRK-A1-01ZSD-110	NC1 LED IŞIKLI STOP MANTAR BUTON 110V AC/DC	STOP	10	105,000 -TL
TRK-A1-01ZSD-24	NC1 LED IŞIKLI STOP MANTAR BUTON 24V AC/DC	STOP	10	105,000 -TL

Ø 40 MM KAYICI BUTONLAR



Ürün Kodu	Ürün Cinsi	Renk	Kutu Miktarı (Ad)	Fiyat TL/Adet
TRK-A3-10M	NO1 START MANTAR BUTON YEŞİL	Yeşil	10	45,000 -TL
TRK-A3-41M	NO1 START MANTAR BUTON SİYAH	Siyah	10	45,000 -TL
TRK-A3-01M	NC1 STOP MANTAR BUTON KIRMIZI	Kırmızı	10	45,000 -TL

Ø 40 MM KALICI ANAHTARLI BUTON

*Tek Kontaklı



Ürün Kodu	Ürün Cinsi	Renk	Kutu Miktarı (Ad)	Fiyat TL/Adet
TRK-BZ-01ZA	NC1 ANAHTARLI STOP MANTAR BUTON KIRMIZI	Kırmızı	10	90,000 -TL

İKİZ BUTONLAR

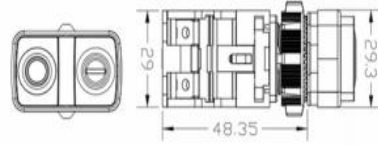

Ürün Kodu	Ürün Cinsi	Renk	Voltaj	Kutu Miktarı (Ad)	Fiyat TL/Adet
TRK-A3-11R	NO1+NC1 İKİZ BUTON	Kırmızı/Yeşil	220V AC/DC	10	80,000 -TL
TRK-A3-11RD	NO1+NC1 IŞIKLI İKİZ BUTON	Kırmızı/Yeşil	220V AC/DC	10	100,000 -TL
TRK-A3-11RD-110	NO1+NC1 IŞIKLI İKİZ BUTON	Kırmızı/Yeşil	110V AC/DC	10	100,000 -TL
TRK-A5-11RD-24V	NO1+NC1 IŞIKLI İKİZ BUTON	Kırmızı/Yeşil	24V AC/DC	10	100,000 -TL

JOYSTICK VİNÇ BUTON



Ürün Kodu	Ürün Cinsi	Çap mm	Kutu Miktarı (Ad)	Koli Miktarı (Ad)	Fiyat TL/Adet
TRK-PA22	İKİ YÖNLÜ JOYSTICK	22	10	300	110,000 -TL
TRK-PA24	DÖRT YÖNLÜ JOYSTICK	22	10	300	150,000 -TL

Ø 22 MM POTANSİYOMETRELER



Ürün Kodu	Ürün Cinsi	Voltaj	Ambalaj Miktarı (Ad)	Koli Miktarı (Ad)	Fiyat TL/Adet
LA42DWQ-5K	Ø22 POTANSİYOMETRE 5K	220V AC	10	500	103,000 -TL
LA42DWQ-10K	Ø22 POTANSİYOMETRE 10K	220V AC	10	500	103,000 -TL

PANO İÇİ TERMOSTATLAR



Ürün Kodu	Ürün Cinsi	Kontak Tipi	Açıklama	Kutu Miktarı (Ad)	Fiyat TL/Adet
KTO-011	PANO TERMOSTAT (KIRMIZI)	NC	Isıtma Termostatı (0-60°C)	1	153,00 -TL
KTS-011	PANO TERMOSTAT (MAVİ)	NO	Soğutma Termostatı (0-60°C)	1	153,00 -TL

YEDEK KONTAK BLOKLARI

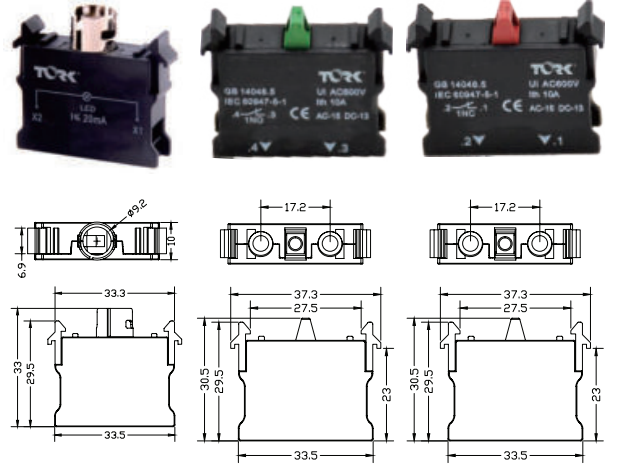

Ürün Kodu	Ürün Cinsi	Kutu Miktarı (Ad)	Fiyat TL/Adet
TRK-A3-1NO	Start Kontak Blok (NO1) (YEŞİL)	50	16,000 -TL
TRK-A3-1NC	Stop Kontak Blok (NC1) (KIRMIZI)	50	16,000 -TL
TRK-A3-A-D2	Led Kontak Blok (GRİ)	50	19,000 -TL

BUTON AKSESUAR



Ürün Kodu	Ürün Cinsi	Kutu Miktarı (Ad)	Fiyat TL/Adet
TRK-FC	Buton Rozeti	100	2,400 -TL
TRK-FD/60	Φ60mm Acil Stop Etiketi	100	6,500 -TL
TRK-EC2	Acil Stop Buton Koruma Kapağı	20	32,000 -TL
TRK-FH	Buton Koruma Kapağı	5	30,000 -TL
TRK-BK	Buton Koruma Kılıfı	100	5,300 -TL

KUTULU MONTAJLI ÜRÜNLER (STOP BUTON)



Ürün Kodu	Ürün Cinsi	Kutu Miktarı (Ad)	Fiyat TL/Adet
TRK-LAY5-BX542KES	1 li Kutulu Plastik Korumalı Acil Stop Butonu 1NC	1	80,000 -TL

“maximum enerji maximum **TORX®**”



DAĞITICI ÜNİTELER

TORX®



DAĞITICI ÜNİTELER

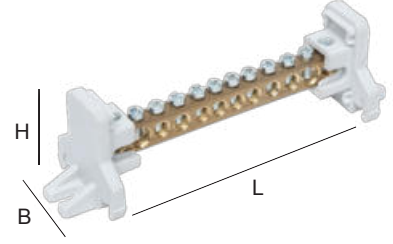

125A DAĞITICI ÜNİTELER 1 KUTUP KAPAKSIZ TİP (7X12mm)

Ürün Kodu	Ürün Cinsi	Amper	L mm	H mm	B mm	Giriş mm Ø	Çıkış mm Ø	Ambalaj Miktarı (Ad)	Fiyat TL/Adet	
DUNT107-125A	2+5 Delik Dağıtıcı Ünite (125A)	KAPAKSIZ	125A	67	40	40	2x8,5	5x5,5	50	71,50 -TL
DUNT110-125A	2+8 Delik Dağıtıcı Ünite (125A)	KAPAKSIZ	125A	89	40	40	2x8,5	8x5,5	40	90,50 -TL
DUNT112-125A	2+10 Delik Dağıtıcı Ünite (125A)	KAPAKSIZ	125A	104	40	40	2x8,5	10x5,5	30	102,50 -TL
DUNT115-125A	2+13 Delik Dağıtıcı Ünite (125A)	KAPAKSIZ	125A	126	40	40	2x8,5	13x5,5	30	122,50 -TL
DUNT120-125A	2+18 Delik Dağıtıcı Ünite (125A)	KAPAKSIZ	125A	170	40	40	2x8,5	18x5,5	20	153,00 -TL

*Diğer ölçüler için stok sorunuz..

80A DAĞITICI ÜNİTELER 2 KUTUP KAPAKLI TİP (6,5X9mm)

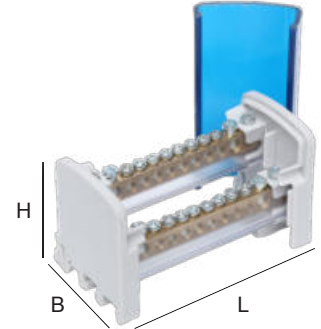

Ürün Kodu	Ürün Cinsi	Amper	L mm	H mm	B mm	Giriş mm Ø	Çıkış mm Ø	Ambalaj Miktarı (Ad)	Fiyat TL/Adet	
DUNT207-80A	2+5 Delik Dağıtıcı Ünite (80A)	KAPAKLI	80A	67	55	45	2X5,5	5X4,5	30	114,50 -TL
DUNT210-80A	2+8 Delik Dağıtıcı Ünite (80A)	KAPAKLI	80A	70,5	55	45	2X5,5	8X4,5	20	145,00 -TL
DUNT212-80A	2+10 Delik Dağıtıcı Ünite (80A)	KAPAKLI	80A	91	55	45	2X5,5	10X4,5	20	165,00 -TL
DUNT215-80A	2+13 Delik Dağıtıcı Ünite (80A)	KAPAKLI	80A	107	55	45	2X5,5	13X4,5	20	180,00 -TL
DUNT220-80A	2+18 Delik Dağıtıcı Ünite (80A)	KAPAKLI	80A	136	55	45	2X5,5	18X4,5	10	220,00 -TL
DUNT222-80A	2+20 Delik Dağıtıcı Ünite (80A)	KAPAKLI	80A	150	55	45	2X5,5	20X4,5	10	240,00 -TL
DUNT225-80A	2+23 Delik Dağıtıcı Ünite (80A)	KAPAKLI	80A	163	55	45	2X5,5	23X4,5	10	263,00 -TL

DAĞITICI ÜNİTELER

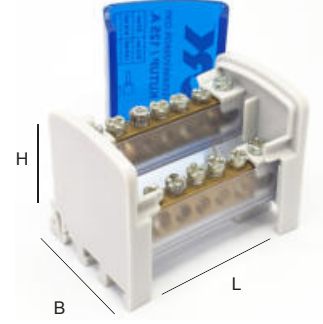

125A DAĞITICI ÜNİTELER 2 KUTUP KAPAKLI TİP (7X12mm)

Ürün Kodu	Ürün Cinsi		Amper	L mm	H mm	B mm	Giriş mm Ø	Çıkış mm Ø	Ambalaj Miktarı (Ad)	Fiyat TL/Adet
DUNT207-125A	2+5 Delik Dağıtıcı Ünite (125A)	KAPAKLI	125A	67	55	45	2X8,5	5X5,5	30	130,00 -TL
DUNT210-125A	2+8 Delik Dağıtıcı Ünite (125A)	KAPAKLI	125A	89	55	45	2X8,5	8X5,5	20	170,00 -TL
DUNT212-125A	2+10 Delik Dağıtıcı Ünite (125A)	KAPAKLI	125A	104	55	45	2X8,5	10X5,5	20	196,00 -TL
DUNT215-125A	2+13 Delik Dağıtıcı Ünite (125A)	KAPAKLI	125A	126	55	45	2X8,5	13X5,5	20	240,00 -TL
DUNT220-125A	2+18 Delik Dağıtıcı Ünite (125A)	KAPAKLI	125A	170	55	45	2X8,5	18X5,5	10	305,00 -TL
DUNT222-125A	2+20 Delik Dağıtıcı Ünite (125A)	KAPAKLI	125A	178	55	45	2X8,5	20X5,5	10	335,00 -TL
DUNT225-125A	2+23 Delik Dağıtıcı Ünite (125A)	KAPAKLI	125A	201	55	45	2X8,5	23X5,5	10	370,00 -TL

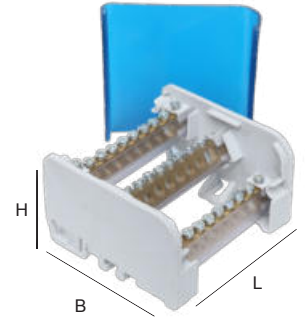

80A DAĞITICI ÜNİTELER 3 KUTUP KAPAKLI TİP (7X12mm)

Ürün Kodu	Ürün Cinsi		Amper	L mm	H mm	B mm	Giriş mm Ø	Çıkış mm Ø	Ambalaj Miktarı (Ad)	Fiyat TL/Adet
DUNT307-80A	2+5 Delik Dağıtıcı Ünite (80A)	KAPAKLI	80A	67	55	85	2X5,5	5X4,5	15	211,00 -TL
DUNT310-80A	2+8 Delik Dağıtıcı Ünite (80A)	KAPAKLI	80A	70,5	55	85	2X5,5	8X4,5	10	265,00 -TL
DUNT312-80A	2+10 Delik Dağıtıcı Ünite (80A)	KAPAKLI	80A	91	55	85	2X5,5	10X4,5	10	302,00 -TL
DUNT315-80A	2+13 Delik Dağıtıcı Ünite (80A)	KAPAKLI	80A	107	55	85	2X5,5	13X4,5	10	348,00 -TL
DUNT320-80A	2+18 Delik Dağıtıcı Ünite (80A)	KAPAKLI	80A	136	55	85	2X5,5	18X4,5	5	435,00 -TL
DUNT322-80A	2+20 Delik Dağıtıcı Ünite (80A)	KAPAKLI	80A	150	55	85	2X5,5	20X4,5	5	475,00 -TL
DUNT325-80A	2+23 Delik Dağıtıcı Ünite (80A)	KAPAKLI	80A	163	55	85	2X5,5	23X4,5	5	525,00 -TL

125A DAĞITICI ÜNİTELER 3 KUTUP KAPAKLI TİP (7X12mm)

Ürün Kodu	Ürün Cinsi		Amper	L mm	H mm	B mm	Giriş mm Ø	Çıkış mm Ø	Ambalaj Miktarı (Ad)	Fiyat TL/Adet
DUNT307-125A	2+5 Delik Dağıtıcı Ünite (125A)	KAPAKLI	125A	67	55	85	2X8,5	5X5,5	15	255,00 -TL
DUNT310-125A	2+8 Delik Dağıtıcı Ünite (125A)	KAPAKLI	125A	89	55	85	2X8,5	8X5,5	10	302,00 -TL
DUNT312-125A	2+10 Delik Dağıtıcı Ünite (125A)	KAPAKLI	125A	104	55	85	2X8,5	10X5,5	10	345,00 -TL
DUNT315-125A	2+13 Delik Dağıtıcı Ünite (125A)	KAPAKLI	125A	126	55	85	2X8,5	13X5,5	10	420,00 -TL
DUNT320-125A	2+18 Delik Dağıtıcı Ünite (125A)	KAPAKLI	125A	170	55	85	2X8,5	18X5,5	5	540,00 -TL
DUNT322-125A	2+20 Delik Dağıtıcı Ünite (125A)	KAPAKLI	125A	178	55	85	2X8,5	20X5,5	5	595,00 -TL
DUNT325-125A	2+23 Delik Dağıtıcı Ünite (125A)	KAPAKLI	125A	201	55	85	2X8,5	23X5,5	5	660,00 -TL



DAĞITICI ÜNİTELER

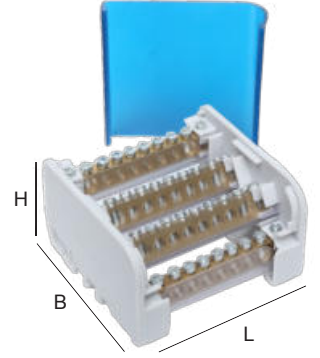

80A DAĞITICI ÜNİTELER 4 KUTUP KAPAKLI TİP (6,5X9mm)

Ürün Kodu	Ürün Cinsi		Amper	L mm	H mm	B mm	Giriş mm Ø	Çıkış mm Ø	Ambalaj Miktarı (Ad)	Fiyat TL/Adet
DUNT407-80A	2+5 Delik Dağıtıcı Ünite (80A)	KAPAKLI	80A	67	55	85	2X5,5	5X4,5	15	240,00 -TL
DUNT410-80A	2+8 Delik Dağıtıcı Ünite (80A)	KAPAKLI	80A	70,5	55	85	2X5,5	8X4,5	10	303,00 -TL
DUNT412-80A	2+10 Delik Dağıtıcı Ünite (80A)	KAPAKLI	80A	91	55	85	2X5,5	10X4,5	10	345,00 -TL
DUNT415-80A	2+13 Delik Dağıtıcı Ünite (80A)	KAPAKLI	80A	107	55	85	2X5,5	13X4,5	10	395,00 -TL
DUNT420-80A	2+18 Delik Dağıtıcı Ünite (80A)	KAPAKLI	80A	136	55	85	2X5,5	18X4,5	5	490,00 -TL
DUNT422-80A	2+20 Delik Dağıtıcı Ünite (80A)	KAPAKLI	80A	150	55	85	2X5,5	20X4,5	5	525,00 -TL
DUNT425-80A	2+23 Delik Dağıtıcı Ünite (80A)	KAPAKLI	80A	163	55	85	2X5,5	23X4,5	5	595,00 -TL

125A DAĞITICI ÜNİTELER 4 KUTUP KAPAKLI TİP (7X12mm)

Ürün Kodu	Ürün Cinsi		Amper	L mm	H mm	B mm	Giriş mm Ø	Çıkış mm Ø	Ambalaj Miktarı (Ad)	Fiyat TL/Adet
DUNT407-125A	2+5 Delik Dağıtıcı Ünite (125A)	KAPAKLI	125A	67	55	85	2X8,5	5X5,5	15	255,00 -TL
DUNT410-125A	2+8 Delik Dağıtıcı Ünite (125A)	KAPAKLI	125A	89	55	85	2X8,5	8X5,5	10	325,00 -TL
DUNT412-125A	2+10 Delik Dağıtıcı Ünite (125A)	KAPAKLI	125A	104	55	85	2X8,5	10X5,5	10	375,00 -TL
DUNT415-125A	2+13 Delik Dağıtıcı Ünite (125A)	KAPAKLI	125A	126	55	85	2X8,5	13X5,5	10	445,00 -TL
DUNT420-125A	2+18 Delik Dağıtıcı Ünite (125A)	KAPAKLI	125A	170	55	85	2X8,5	18X5,5	5	575,00 -TL
DUNT422-125A	2+20 Delik Dağıtıcı Ünite (125A)	KAPAKLI	125A	178	55	85	2X8,5	20X5,5	5	630,00 -TL
DUNT425-125A	2+23 Delik Dağıtıcı Ünite (125A)	KAPAKLI	125A	201	55	85	2X8,5	23X5,5	5	695,00 -TL

TOPRAKLAMA KLEMENSLERİ

80A Ayaksız Pano Topraklama Klemensleri (6,5X9mm)

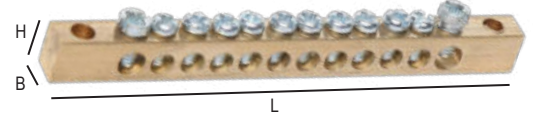

Ürün Kodu	Ürün Cinsi	Amper	Delik sayısı	Ölçüler			Ambalaj Miktarı (Ad)	Fiyat	
				L mm	H mm	B mm		TL/Adet	
APTK-80A06	6 Delikli Ayaksız Pano Topraklama Klemensi (80A)	80	6	65	9	6,5	20	27,50	-TL
APTK-80A07	7 Delikli Ayaksız Pano Topraklama Klemensi (80A)	80	7	72	9	6,5	20	29,00	-TL
APTK-80A09	9 Delikli Ayaksız Pano Topraklama Klemensi (80A)	80	9	85	9	6,5	20	35,00	-TL
APTK-80A10	10 Delikli Ayaksız Pano Topraklama Klemensi (80A)	80	10	92	9	6,5	20	38,00	-TL
APTK-80A12	12 Delikli Ayaksız Pano Topraklama Klemensi (80A)	80	12	105	9	6,5	20	44,50	-TL
APTK-80A15	15 Delikli Ayaksız Pano Topraklama Klemensi (80A)	80	15	131	9	6,5	20	51,00	-TL
APTK-80A20	20 Delikli Ayaksız Pano Topraklama Klemensi (80A)	80	20	160	9	6,5	20	65,00	-TL
APTK-80A22	22 Delikli Ayaksız Pano Topraklama Klemensi (80A)	80	22	160	9	6,5	20	70,50	-TL
APTK-80A25	25 Delikli Ayaksız Pano Topraklama Klemensi (80A)	80	25	170	9	6,5	20	78,00	-TL

*Diğer ölçüler için stok sorunuz..

125A Ayaksız Pano Topraklama Klemensleri (7X12mm)

Ürün Kodu	Ürün Cinsi	Amper	Delik sayısı	Ölçüler			Ambalaj Miktarı (Ad)	Fiyat	
				L mm	H mm	B mm		TL/Adet	
APTK-125A06	6 Delikli Ayaksız Pano Topraklama Klemensi (125A)	125	6	65	12	7	20	40,50	-TL
APTK-125A07	7 Delikli Ayaksız Pano Topraklama Klemensi (125A)	125	7	72	12	7	20	44,50	-TL
APTK-125A09	9 Delikli Ayaksız Pano Topraklama Klemensi (125A)	125	9	85	12	7	20	54,50	-TL
APTK-125A10	10 Delikli Ayaksız Pano Topraklama Klemensi (125A)	125	10	92	12	7	20	56,50	-TL
APTK-125A12	12 Delikli Ayaksız Pano Topraklama Klemensi (125A)	125	12	105	12	7	20	66,00	-TL
APTK-125A15	15 Delikli Ayaksız Pano Topraklama Klemensi (125A)	125	15	131	12	7	20	79,00	-TL
APTK-125A20	20 Delikli Ayaksız Pano Topraklama Klemensi (125A)	125	20	160	12	7	20	101,50	-TL
APTK-125A22	22 Delikli Ayaksız Pano Topraklama Klemensi (125A)	125	22	178	12	7	20	115,50	-TL
APTK-125A25	25 Delikli Ayaksız Pano Topraklama Klemensi (125A)	125	25	178	12	7	20	123,00	-TL

*Diğer ölçüler için stok sorunuz..



NÖTR KLEMENSLERİ

80A Ayaklı Pano Nötr Klemensleri (6,5X9mm)

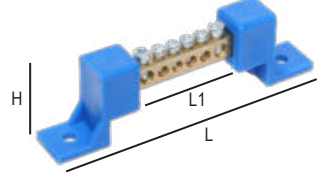

Ürün Kodu	Ürün Cinsi	Amper	Delik sayısı	Ölçüler			Ambalaj Miktarı (Ad)	Fiyat	
				L mm	L1 mm	H mm		TL/Adet	
PNK-80A06	6 Delikli Ayaklı Pano Nötr Topraklama Klemensi (80A)	80	6	100	67	30	20	29,50	-TL
PNK-80A07	7 Delikli Ayaklı Pano Nötr Topraklama Klemensi (80A)	80	7	105	74	30	20	31,50	-TL
PNK-80A09	9 Delikli Ayaklı Pano Nötr Topraklama Klemensi (80A)	80	9	118	87	30	20	37,00	-TL
PNK-80A10	10 Delikli Ayaklı Pano Nötr Topraklama Klemensi (80A)	80	10	123	94	30	20	39,50	-TL
PNK-80A12	12 Delikli Ayaklı Pano Nötr Topraklama Klemensi (80A)	80	12	134	107	30	20	44,50	-TL
PNK-80A15	15 Delikli Ayaklı Pano Nötr Topraklama Klemensi (80A)	80	15	151	133	30	20	52,00	-TL
PNK-80A20	20 Delikli Ayaklı Pano Nötr Topraklama Klemensi (80A)	80	20	151	133	30	20	65,50	-TL
PNK-80A22	22 Delikli Ayaklı Pano Nötr Topraklama Klemensi (80A)	80	22	192	163	30	20	73,50	-TL
PNK-80A25	25 Delikli Ayaklı Pano Nötr Topraklama Klemensi (80A)	80	25	200	170	30	20	77,50	-TL

*Diğer ölçüler için stok sorunuz..

125A Ayaklı Pano Nötr Klemensleri (7x12mm)

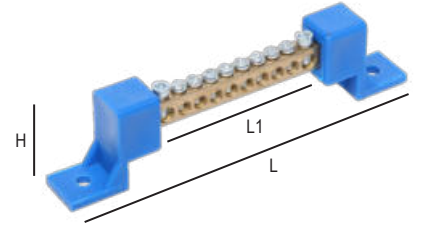

Ürün Kodu	Ürün Cinsi	Amper	Delik sayısı	Ölçüler			Ambalaj Miktarı (Ad)	Fiyat	
				L mm	L1 mm	H mm		TL/Adet	
PNK-125A06	6 Delikli Ayaklı Pano Nötr Topraklama Klemensi (125A)	125	6	107	67	30	20	45,00	-TL
PNK-125A07	7 Delikli Ayaklı Pano Nötr Topraklama Klemensi (125A)	125	7	123	74	30	20	48,50	-TL
PNK-125A09	9 Delikli Ayaklı Pano Nötr Topraklama Klemensi (125A)	125	9	131	87	30	20	59,00	-TL
PNK-125A10	10 Delikli Ayaklı Pano Nötr Topraklama Klemensi (125A)	125	10	147	94	30	20	62,50	-TL
PNK-125A12	12 Delikli Ayaklı Pano Nötr Topraklama Klemensi (125A)	125	12	171	107	30	20	72,50	-TL
PNK-125A15	15 Delikli Ayaklı Pano Nötr Topraklama Klemensi (125A)	125	15	206	133	30	20	85,00	-TL
PNK-125A20	20 Delikli Ayaklı Pano Nötr Topraklama Klemensi (125A)	125	20	206	133	30	20	115,00	-TL
PNK-125A22	22 Delikli Ayaklı Pano Nötr Topraklama Klemensi (125A)	125	22	220	180	30	20	125,00	-TL
PNK-125A25	25 Delikli Ayaklı Pano Nötr Topraklama Klemensi (125A)	125	25	220	180	30	20	140,00	-TL

*Diğer ölçüler için stok sorunuz..

“maximum enerji maximum **TORX®**”

ISI İLE DARALAN MAKARONLAR



MAKARONLAR

ISI İLE DARALAN MAKARONLAR (2/1)



SİYAH

Ürün Kodu	Ölçüler		Daralmadan Önce (mm)		Daralmadan Sonra (mm)		Makara (MT)	Fiyat	
	Inc (Ø)	mm	İç Çap	Cidar Kalınlığı	İç Çap	Cidar Kalınlığı		USD/MT	-USD
MK-001,5-S	-	1,5	2.0±0.2	0.18±0.05	0,85	0.32±0.10	200	0,097	-USD
MK-002,0-S	-	2,0	2.5±0.2	0.18±0.05	0,60	0.28±0.10	200	0,115	-USD
MK-002,5-S	3/32	2,5	3.0±0.2	0.18±0.05	1,30	0.38±0.10	200	0,115	-USD
MK-003,0-S	-	3,0	3.5±0.2	0.18±0.05	1,50	0.40±0.10	200	0,160	-USD
MK-003,5-S	1/8	3,5	4.0±0.2	0.22±0.05	1,80	0.42±0.10	200	0,170	-USD
MK-004,0-S	-	4,0	4.5±0.2	0.25±0.05	2,00	0.45±0.10	200	0,200	-USD
MK-004,5-S	-	4,5	5.0±0.2	0.25±0.05	2,30	0.50±0.10	100	0,230	-USD
MK-005,0-S	-	5,0	5.5±0.2	0.25±0.05	2,50	0.55±0.10	100	0,250	-USD
MK-006,0-S	-	6,0	6.5±0.2	0.28±0.05	3,00	0.55±0.10	100	0,290	-USD
MK-007,0-S	-	7,0	7.5±0.3	0.28±0.05	3,50	0.55±0.10	100	0,350	-USD
MK-008,0-S	-	8,0	8.5±0.3	0.28±0.05	4,00	0.60±0.10	100	0,350	-USD
MK-009,0-S	3/8	9,0	9.5±0.3	0.30±0.08	4,50	0.60±0.10	100	0,350	-USD
MK-010,0-S	-	10,0	10.5±0.3	0.30±0.08	5,00	0.60±0.10	100	0,390	-USD
MK-012,0-S	1/2	12,0	13.0±0.5	0.30±0.08	6,40	0.60±0.10	100	0,450	-USD
MK-013,0-S	-	13,0	13.5±0.3	0.35±0.10	6,50	0.65±0.10	100	0,480	-USD
MK-014,0-S	-	14,0	14.5±0.3	0.35±0.10	7,00	0.65±0.10	100	0,560	-USD
MK-015,0-S	-	15,0	15.5±0.3	0.35±0.10	7,00	0.65±0.10	100	0,750	-USD
MK-016,0-S	4/5	16,0	16.5±0.4	0.40±0.12	8,00	0.70±0.10	100	0,750	-USD
MK-017,0-S	-	17,0	17.5±0.4	0.40±0.12	8,50	0.70±0.10	100	0,980	-USD
MK-018,0-S	-	18,0	19.0±0.5	0.40±0.15	9,00	0.80±0.15	100	0,980	-USD

*Diğer ölçüler için stok sorunuz..

MAKARONLAR

ISI İLE DARALAN MAKARONLAR (2/1)



SİYAH

Ürün Kodu	Ölçüler		Daralmadan Önce (mm)		Daralmadan Sonra (mm)		Makara (MT)	Fiyat	
	Inc (Ø)	mm	İç Çap	Cidar Kalınlığı	İç Çap	Cidar Kalınlığı		USD/MT	
MK-020,0-S	-	20,0	21.0 ± 0.7	0.40±0.15	10,00	0.80±0.15	100	1,250	-USD
MK-022,0-S	-	22,0	23.0 ± 0.7	0.40±0.15	11,00	0.80±0.15	100	1,550	-USD
MK-025,0-S	1	25,0	25,6 ± 0.7	0.50±0.15	12,70	0.80±0.15	50	1,650	-USD
MK-030,0-S	-	30,0	31.5 ± 0.7	0.50±0.15	15,00	0.90±0.15	50	2,150	-USD
MK-032,0-S	1-1/4	32,0	33.0 ± 0.7	0.50±0.15	15,90	0.95±0.15	50	2,150	-USD
MK-035,0-S	-	35,0	36.5 ± 0.7	0.50±0.15	17,50	0.95±0.15	50	2,700	-USD
MK-038,0-S	1-1/2	38,0	40.0 ± 0.7	0.50±0.15	19,10	1.00±0.15	50	3,000	-USD
MK-040,0-S	-	40,0	41.50 ± 0.7	0.55±0.15	20,00	1.00±0.15	50	3,000	-USD
MK-051,0-S	2	51,0	52.5 ± 0.7	0.55±0.15	25,40	0.95±0.15	25	3,800	-USD
MK-060,0-S	-	60,0	60.5 ± 0.8	0.60±0.15	30,00	1.30±0.20	25	5,100	-USD
MK-070,0-S	-	70,0	70.5 ± 1.0	0.65±0.15	35,00	1.30±0.20	25	6,800	-USD
MK-080,0-S	3	80,0	82 ± 1.0	0.65±0.15	40,00	1.46±0.20	25	7,500	-USD
MK-090,0-S	-	90,0	90 ± 1.0	0.65±0.15	45,00	1.46±0.20	25	8,500	-USD
MK-100,0-S	4	100,0	100.0 ± 1.0	0.65±0.20	50,80	1.46±0.20	25	9,500	-USD
MK-120,0-S	-	120,0	120.0 ± 1.0	0.65±0.15	60,00	1.46±0.20	25	13,000	-USD
MK-150,0-S	-	150,0	105.0 ± 1.0	0.65±0.20	76,00	1.46±0.20	25	19,000	-USD

*Diğer ölçüler için stok sorunuz..

MAKARONLAR

RENKLİ ISI İLE DARALAN MAKARONLAR (2/1)



Ürün Kodu	Ölçüler		Daralmadan Önce (mm)		Daralmadan Sonra (mm)		Makara (MT)	Fiyat	
	Inc (Ø)	mm	İç Çap	Cıdar Kalınlığı	İç Çap	Cıdar Kalınlığı		USD/MT	
MK-002,0-RN	1/16	2,0	2.5±0.2	0.18±0.05	0,60	0.28±0.10	200	0,170	-USD
MK-002,5-RN	3/32	2,5	3.0±0.2	0.18±0.05	1,30	0.38±0.10	200	0,170	-USD
MK-003,5-RN	1/8	3,5	4.0±0.2	0.22±0.05	1,80	0.42±0.10	200	0,210	-USD
MK-005,0-RN	3/16	5,0	5.5±0.2	0.25±0.05	2,50	0.55±0.10	100	0,270	-USD
MK-006,4-RN	3/16	6,4	6.4±0.2	0.25±0.05	2,50	0.55±0.10	100	0,330	-USD
MK-009,5-RN	1/4	9,5	9.5±0.3	0.28±0.05	3,50	0.55±0.10	100	0,390	-USD
MK-012,7-RN	1/2	12,7	13.0±0.5	0.30±0.08	6,40	0.60±0.10	100	0,550	-USD
MK-016,0-RN	1/2	16,0	16.5±0.4	0.40±0.12	8,00	0.70±0.10	100	0,850	-USD
MK-020,0-RN	4/5	20,0	21.0±0.5	0.40±0.10	10,00	0.80±0.15	100	1,500	-USD
MK-025-RN	1	25,0	25.0±0.7	0.50±0.15	12,70	0.80±0.15	50	1,900	-USD
MK-032,0-RN	1-1/4	32,0	33.0±0.7	0.50±0.15	15,90	0.95±0.15	50	2,400	-USD
MK-035,0-RN	1-1/4	35,0	36.5±1.0	0.50±0.15	17,50	0.95±0.15	50	3,600	-USD
MK-038,0-RN	1-1/2	38,0	40.0±0.7	0.50±0.15	19,10	1.00±0.15	50	3,600	-USD
MK-051,0-RN	2	51,0	52.5±0.7	0.55±0.15	25,40	0.95±0.15	25	4,200	-USD
MK-060,0-RN	2	60,0	60	0.60±0.15	30,00	1.30±0.20	25	5,800	-USD
MK-070,0-RN	2	70,0	70	0.65±0.15	35,00	1.30±0.20	25	8,000	-USD
MK-076,0-RN	3	76,0	80.0±1.0	0.65±0.15	38,10	1.30±0.20	25	8,000	-USD
MK-096,0-RN	3	96,0	96	0.65±0.15	50,00	1.46±0.20	25	11,000	-USD
MK-102,0-RN	4	102,0	105.0±1.0	0.65±0.20	50,80	1.46±0.20	25	11,000	-USD

*Diğer ölçüler için stok sorunuz..

*Fiyatlarımıza KDV dahil değildir.

MAKARONLAR

RENKLİ ISI İLE DARALAN MAKARONLAR (2/1)

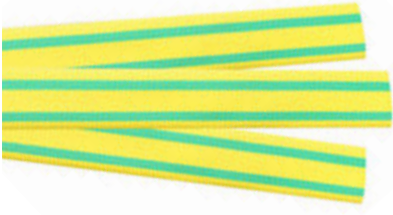

SARI-YEŞİL



Ürün Kodu	Ölçüler		Daralmadan Önce (mm)		Daralmadan Sonra (mm)		Makara (m)	Fiyat	
	Inc (Ø)	mm	İç Çap	Cıdar Kalınlığı	İç Çap	Cıdar Kalınlığı		USD/MT	
MK-003,2-SY	1/8	3,2	3.5±0.4	0.18±0.05	1,60	0.40±0.10	200	0,430	-USD
MK-004,8-SY	3/16	4,8	5.2±0.4	0.25±0.05	2,40	0.50±0.10	100	0,440	-USD
MK-006,4-SY	1/4	6,4	7.0±0.4	0.28±0.05	3,20	0.55±0.10	100	0,500	-USD
MK-009,5-SY	3/8	9,5	10.0±0.5	0.30±0.08	4,80	0.60±0.10	100	0,680	-USD
MK-012,7-SY	1/2	12,7	13.0±0.5	0.30±0.08	6,40	0.60±0.10	100	1,000	-USD
MK-016,0-SY	1/2	16,0	16.5±0.4	0.40±0.12	8,00	0.70±0.10	100	1,450	-USD
MK-020,0-SY	4/5	20,0	21.0±0.5	0.40±0.10	10,00	0.80±0.15	100	1,900	-USD
MK-025,4-SY	1	25,4	25.6.0±0.7	0.50±0.15	12,70	0.80±0.15	50	2,750	-USD
MK-032,0-SY	1-1/4	32,0	33.0±0.7	0.50±0.15	15,90	0.95±0.15	50	3,700	-USD
MK-035,0-SY	1-1/4	35,0	36.5±1.0	0.50±0.15	17,50	0.95±0.15	50	4,750	-USD
MK-038,0-SY	1-1/2	38,0	40.0±0.7	0.50±0.15	19,10	1.00±0.15	50	5,000	-USD
MK-051,0-SY	2	51,0	52.5±0.7	0.55±0.15	25,40	0.95±0.15	25	7,000	-USD
MK-060,0-SY	2	60,0	60	0.60±0.15	30,00	1.30±0.20	25	10,000	-USD
MK-076,0-SY	3	76,0	80.0±1.0	0.65±0.15	38,10	1.30±0.20	25	15,000	-USD
MK-102,0-SY	4	102,0	105.0±1.0	0.65±0.20	50,80	1.46±0.20	25	23,000	-USD

*Diğer ölçüler için stok sorunuz..

MAKARONLAR

İÇİ YAPIŞKANLI MAKARONLAR (3/1)



Ürün Kodu	Ölçü (mm)	Daralmadan Önce (mm)			Daralmadan Sonra (mm)		Makara (MT)	Fiyat	
		İç Çap (mm)	Cidar Kalınlığı	Yapışkan Katmanı	İç Çap (mm)	Cidar Kalınlığı		USD/MT	
MK-004,8-YP	4,8	4,8	1.10±0.10	0,40	1.60±0.10	1.10±0.10	100	0,800	-USD
MK-006,4-YP	6,4	6,2	1.20±0.10	0,45	2.00±0.10	1.20±0.10	100	1,200	-USD
MK-009,5-YP	9,5	9,5	1.45±0.10	0,50	3.15±0.10	1.45±0.25	50	1,600	-USD
MK-012,5-YP	12,5	12,5	1.60±0.20	0,50	4.16±0.10	2.45±0.25	1,22	2,300	-USD
MK-016,0-YP	16,0	16,0	1.45±0.20	0,35	5.30±0.10	1.75±0.25	1,22	3,200	-USD
MK-019,1-YP	19,1	19,0	1.50±0.20	0,40	6.30±0.10	1.90±0.25	1,22	4,500	-USD
MK-025,4-YP	25,4	25,0	2.00±0.20	0,45	8.50±0.10	1.45±0.25	1,22	5,100	-USD
MK-028,0-YP	28,0	28,0	2.00±0.20	0,50	9.00±0.10	2.70±0.25	1,22	5,100	-USD
MK-033,0-YP	33,0	33,0	2.20±0.20	0,50	11.00±0.10	2.70±0.25	1,22	5,800	-USD
MK-040,0-YP	40,0	40,0	2.20±0.20	0,50	13.30±0.10	2.70±0.25	1,22	6,400	-USD
MK-044,0-YP	44,0	44,0	2.30±0.25	0,50	16.60±0.10	2.80±0.30	1,22	7,100	-USD
MK-055,0-YP	55,0	52,0	2.30±0.25	0,50	18.00±0.10	2.80±0.30	1,22	8,000	-USD
MK-070,0-YP	70,0	70,0	2.60±0.25	0,50	24.00±0.10	3.00±0.30	1,22	11,500	-USD
MK-090,0-YP	90,0	90,0	2.60±0.25	0,50	30.00±0.10	3.00±0.30	1,22	16,000	-USD

*Diğer ölçüler için stok sorunuz..

KABLO TOPLAMA ÇORAPLARI



SİYAH / GRİ



Ürün Kodu	Min. Tutma Çapı Ø	Max. Tutma Çapı Ø	Makara (MT)	Fiyat USD/MT
KTC-06	6	11	100	0,2700 -USD
KTC-08	8	12	100	0,2800 -USD
KTC-10	10	15	100	0,3400 -USD
KTC-15	15	27	100	0,4600 -USD
KTC-20	20	28	100	0,5300 -USD
KTC-25	25	34	100	0,6800 -USD
KTC-30	30	37	100	0,8200 -USD
KTC-44	44	45	100	1,6000 -USD

"maximum enerji maximum **TORK**"

SIKMA - KESME BİR ARADA

www.torkelektroteknik.com



MEKANİK PABUÇ SIKMA PENSELERİ

JY-0650A 6-50mm² PABUÇ SIKMA PENSESİ

ÜRÜN FİYATI
75,00-USD

Sıkma Aralığı : 6-50mm² CU
Uzunluk : 380 mm
Ağırlık : 1,5 kg

JY-06120 6-120 mm² PABUÇ SIKMA PENSESİ

ÜRÜN FİYATI
148,00-USD

Sıkma Aralığı : 6-120mm² CU
Uzunluk : 650 mm
Ağırlık : 3,8 kg

JY-25150 25-150 mm² PABUÇ SIKMA PENSESİ

ÜRÜN FİYATI
160,00-USD

Sıkma Aralığı : 25-150mm² CU
Uzunluk : 650 mm
Ağırlık : 3,8 kg

JY-70240 70-240 mm² PABUÇ SIKMA PENSESİ

ÜRÜN FİYATI
185,00-USD

Sıkma Aralığı : 70-240mm² CU
Uzunluk : 670 mm
Ağırlık : 4,0 kg

JT-150 10-150 mm² PABUÇ SIKMA PENSESİ

ÜRÜN FİYATI
350,00-USD

Sıkma Kuvveti : 35kN
Sıkma Aralığı : 10-150 mm² CU
6-120 mm² AL

Uzunluk : 590 mm
Ağırlık : 2,5 kg

Sete Dahil Aksesuarlar

1 TAKIM ÇENE (10-16-25-35-50-70-95-120-150)

JT-300 16-300 mm² PABUÇ SIKMA PENSESİ

ÜRÜN FİYATI
500,00-USD

Sıkma Kuvveti : 60kN
Sıkma Aralığı : 16-300 mm² CU
10-240 mm² AL

Uzunluk : 580 mm
Ağırlık : 4,0 kg

Sete Dahil Aksesuarlar

1 TAKIM ÇENE (16-25-35-50-70-95-120-150-185-240-300)

HİDROLİK PABUÇ SIKMA PENSELERİ**YQK-70** 4-70 mm² HİDROLİK PABUÇ SIKMA PENSESİ

Sıkma Ölçüsü	: 4-70 mm ²
Sıkma Kuvveti	: 45KN
Sıkma Tipi	: Altıgen
Açılma Eni	: 10 mm
Uzunluk	: 310 mm
Ağırlık	: 1.8 kg

**ÜRÜN FİYATI**
150,00-USD

Sete Dahil Aksesuarlar
1 TAKIM ÇENE (4-6-10-16-25-35-50-70)
Plastik Çanta

YYQ-120 10-120 mm² HİDROLİK PABUÇ SIKMA PENSESİ

Sıkma Ölçüsü	: 10-120 mm ²
Sıkma Kuvveti	: 60KN
Sıkma Tipi	: Altıgen
Açılma Eni	: 14 mm
Yükseklik	: 425 mm
Ağırlık	: 3.2 kg

**ÜRÜN FİYATI**
150,00-USD

Sete Dahil Aksesuarlar
1 TAKIM ÇENE (10-16-25-35-50-70-95-120)
Plastik Çanta

YYQ-120A 10-120 mm² HİDROLİK PABUÇ SIKMA PENSESİ

Sıkma Ölçüsü	: 10-120 mm ²
Sıkma Kuvveti	: 60KN
Sıkma Tipi	: Altıgen
Açılma Eni	: 14 mm
Yükseklik	: 425 mm
Ağırlık	: 4.0 kg

**ÜRÜN FİYATI**
170,00-USD

Sete Dahil Aksesuarlar
1 TAKIM ÇENE (10-16-25-35-50-70-95-120)
Plastik Çanta

THS-150 10-150 mm² HİDROLİK PABUÇ SIKMA PENSESİ

Sıkma Ölçüsü	: 10-150 mm ²
Sıkma Kuvveti	: 60KN
Sıkma Tipi	: Altıgen
Açılma Eni	: 15 mm
Yükseklik	: 370mm
Ağırlık	: 2.2 kg

ÜRÜN FİYATI
1000,00-USD

Sete Dahil Aksesuarlar
1 TAKIM ÇENE (10-16-25-35-50-70-95-120-150)
Plastik Çanta

HİDROLİK PABUÇ SIKMA PENSELERİ**YQK-300** 16-300 mm² HİDROLİK PABUÇ SIKMA PENSESİ

Sıkma Ölçüsü	: 16-300 mm ²
Sıkma Kuvveti	: 100KN
Sıkma Tipi	: Altıgen
Açılma Eni	: 22 mm
Yükseklik	: 500 mm
Ağırlık	: 3.6 kg

ÜRÜN FİYATI
155,00-USD**Sete Dahil Aksesuarlar**

1 TAKIM ÇENE (16-25-35-50-70-95-120-150-185-240-300)
Plastik Çanta

KYQ-300 16-300 mm² HİDROLİK PABUÇ SIKMA PENSESİ

Sıkma Ölçüsü	: 16-300 mm ²
Sıkma Kuvveti	: 100KN
Sıkma Tipi	: Altıgen
Açılma Eni	: 22 mm
Yükseklik	: 500 mm
Ağırlık	: 4.6 kg

ÜRÜN FİYATI
530,00-USD**Sete Dahil Aksesuarlar**

1 TAKIM ÇENE (16-25-35-50-70-95-120-150-185-240-300)
Plastik Çanta

HZ-60UNV 16-300 mm² HİDROLİK SIKMA - 45 mm KESME-PUNCH / MULTIFUNCTIONAL**SET FİYATI**
1.850,00-USD**Sete Dahil Aksesuarlar**

1 TAKIM ÇENE (16-25-35-50-70-95-120-150-185-240-300)
1 TAKIM PUNCH LOKMA (22,5-28,3-34,6-43,2-49,6-61,5)
1 TAKIM KESME ÇENESİ
Plastik Çanta



Sıkma Kuvveti	: 60kN
Açılma Eni	: 42 mm
Sıkma Ölçüsü	: Cu 16-300 mm ² / Al 10-240 mm ²
Kesme Ölçüsü	: 45 mm Cu/Al ve Zırlı kablo
Punch Aralığı	: c 22.5-61,5mm

HİDROLİK PABUÇ SIKMA PENSELERİ**HZ-300** 16-300 mm² HİDROLİK PABUÇ SIKMA PENSESİ

Sıkma Ölçüsü	: 16-300 mm ²
Sıkma Kuvveti	: 60KN
Sıkma Tipi	: Altıgen
Açılma Eni	: 17 mm
Uzunluk	: 370 mm
Ağırlık	: 3.3 kg

ÜRÜN FİYATI
1.200,00-USD

Sete Dahil Aksesuarlar

1 TAKIM ÇENE (16-25-35-50-70-95-120-150-185-240-300)
Metal Çanta

HZ-400 16-400 mm² HİDROLİK PABUÇ SIKMA PENSESİ

Sıkma Ölçüsü	: 16-400 mm ²
Sıkma Kuvveti	: 120KN
Sıkma Tipi	: Altıgen
Açılma Eni	: 42 mm
Uzunluk	: 540 mm
Ağırlık	: 6.3 kg

ÜRÜN FİYATI
1.460,00-USD

Sete Dahil Aksesuarlar

1 TAKIM ÇENE (16-25-35-50-70-95-120-150-185-240-300-400)
Metal Çanta

HZ-400U 16-400 mm² HİDROLİK PABUÇ SIKMA PENSESİ

Sıkma Ölçüsü	: 16-400 mm ²
Sıkma Kuvveti	: 120KN
Sıkma Tipi	: Altıgen
Açılma Eni	: 17 mm
Ağırlık	: 5.3 kg

ÜRÜN FİYATI
1.550,00-USD

Sete Dahil Aksesuarlar

1 TAKIM ÇENE (16-25-35-50-70-95-120-150-185-240-300-400)
Metal Çanta

CYO-400C 16-400 mm² HİDROLİK PABUÇ SIKMA PENSESİ

Sıkma Ölçüsü	: 16-400 mm ²
Sıkma Kuvveti	: 120KN
Sıkma Tipi	: Altıgen
Açılma Eni	: 22 mm
Ağırlık	: 5.3 kg
Yağ Kapasitesi	: 145 cc

ÜRÜN FİYATI
1.100,00-USD

Sete Dahil Aksesuarlar

1 TAKIM ÇENE (16-25-35-50-70-95-120-150-185-240-300-400)
Plastik Çanta

HİDROLİK PABUÇ SIKMA PENSELERİ

**CO-400B** 16-400 mm² HİDROLİK PABUÇ SIKMA BAŞLIĞI

Sıkma Ölçüsü	: 16-400 mm ²
Sıkma Kuvveti	: 155KN
Sıkma Tipi	: Altıgen
Açılma Eni	: 22 mm
Yükseklik	: 240 mm
Ağırlık	: 6.5 kg

ÜRÜN FİYATI
500,00-USD**Sete Dahil Aksesuarlar**1 TAKIM ÇENE (16-25-35-50-70-95-120-150-185-240-300-400)
Plastik Çanta**FYQ-630A** 150-630 mm² HİDROLİK PABUÇ SIKMA BAŞLIĞI

Sıkma Ölçüsü	: 150-630 mm ²
Sıkma Kuvveti	: 316KN
Açılma Eni	: 25 mm
Sıkma Tipi	: Altıgen
Ağırlık	: 15.4 kg

ÜRÜN FİYATI
1.400,00-USD**Sete Dahil Aksesuarlar**1 TAKIM ÇENE (150-185-240-300-400-500-630)
Sac Çanta**FYQ-1000** 400-1000 mm² HİDROLİK PABUÇ SIKMA BAŞLIĞI

Sıkma Ölçüsü	: 400-1000mm ²
Sıkma Kuvveti	: 495KN
Açılma Eni	: 28 mm
Sıkma Tipi	: Altıgen
Ağırlık	: 27.3 kg
Ölçüler	: 40,5 x 28 x 15,5

ÜRÜN FİYATI
2.200,00-USD**Sete Dahil Aksesuarlar**1 TAKIM ÇENE (400-500-630-800-1000)
Sac Çanta***Bu ekipmanlar Sayfa 70'deki ürünler ile entegre çalışır.**

ŞARJ EDİLEBİLİR PİLLİ UNIVERSAL TİP PENSELER (PABUÇ SIKMA-KABLO KESME-PUNCH) ED-60UNV



SET FİYATI 5.450,00-USD

Fiyata Dahil Aksesuarlar

- 1 TAKIM ÇENE (16-25-35-50-70-95-120-150-185-240-300)
- 1 TAKIM PUNCH LOKMA (22,5-28,3-34,6-43,2-49,6-61,5)
- 1 TAKIM KESME ÇENESİ
- 1 AD ŞARJ EDİLEBİLİR PİL 18V 3,0 Ah
- 1 AD ŞARJ ALETİ
- PLASTİK ÇANTA



Teknik Özellikler

Sıkma Kuvveti	: 60 Kn
Açılma Eni	: 42 mm
Sıkma Ölçüsü	: 16-300 mm ²
Sıkma Sayısı	: 320 (Cu 150mm ²)
Kesme Ölçüsü	: 40 mm Cu/Al ve Zırlı kablo
Kesme Sayısı	: 70
Punch Aralığı	: Ø 22.5 - Ø 61.5mm
Punch Sayısı	: 100
Pilin Voltajı	: 18V
Pilin Kapasitesi	: 3.0Ah Li-Ion
Şarj Süresi	: 1 Saat

SIKMA



KESME



DELME (PUNCH)



Hidrolik ünite, maksimum çalışma basıncına ulaştığında pistonu başlangıç konumuna geri döndüren otomatik geri çekme mekanizmasına sahiptir.



Elle geri çekme, yanlış kıvrılma durumunda pistonun başrol konumuna geri döndürülmesini sağlar. Ünite, tetik bırakıldığında piston ve kalıbın ileri hareketini durdurduğunda özel bir fren ile durur.



Ünite, kalıpların konektörü ileriye doğru hızlı bir şekilde yaklaşması ve yavaş sıkma hareketi ile karakterize edilen çift pistonlu bir pompa ile donatılmıştır.



Kıvrma kafası, sıkı gelenleri ve diğer zorlu çalışma alanlarına daha iyi erişim sağlamak için uzunlamasına eksenli etrafında düzgün bir şekilde 360° döndürülebilir.



Li-ion bataryaların bellek etkisi ya da kendi kendine boşalması yoktur. Uzun süre çalıştırılmazsa bile alet her zaman çalışmaya hazırdır. Buna ek olarak, NiMH pillerle karşılaştırıldığında %50 daha fazla kapasite ve şarjlı şarj döngüsü ile daha düşük bir güç ağırlık oranı görüyoruz.

ŞARJ EDİLEBİLİR PİLLİ PABUÇ SIKMA/KESME PENSELERİ (DİKEY TİP)

PZ-300 16-300 mm² PABUÇ SIKMA PENSESİ

Teknik Özellikler

Sıkma Kuvveti	: 60 Kn
Açılma Eni	: 17 mm
Sıkma Sayısı	: 300 (Cu 150mm ²)
Pilin Voltajı	: 18V
Pilin Kapasitesi	: 3.0Ah Li-Ion
Şarj Süresi	: 45 dk.

SET FİYATI
3.800,00-USD

Fiyata Dahil Aksesuarlar

1 TAKIM ÇENE (16-25-35-50-70-95-120-150-185-240-300)
1 AD ŞARJ EDİLEBİLİR PİL 18V 3,0 Ah
1 AD ŞARJ ALETİ
PLASTİK ÇANTA



PZ-300C PABUÇ SIKMA/KESME PENSESİ

Teknik Özellikler

Açılma Eni	: 17 mm
Kesme Ölçüsü	: 300 mm ² Cu 240 mm ² Al
Pilin Voltajı	: 18V
Pilin Kapasitesi	: 3.0Ah Li-Ion
Şarj Süresi	: 45 dk.

SET FİYATI
4.100,00-USD

Fiyata Dahil Aksesuarlar

1 TAKIM ÇENE (16-25-35-50-70-95-120-150-185-240-300)
1 TAKIM KESME ÇENESİ
1 AD ŞARJ EDİLEBİLİR PİL 18V 3,0 Ah
1 AD ŞARJ ALETİ
PLASTİK ÇANTA



**SIKMA - KESME
BİR ARADA**



Hidrolik ünite, maksimum çalışma basıncına ulaştığında pistonu başlangıç konumuna geri döndüren otomatik geri çekme mekanizmasına sahiptir.



Elle geri çekme, yanlış kıvrılma durumunda pistonun başrol konumuna geri döndürülmesini sağlar. Ünite, tetik bırakıldığında piston ve kalıbın ileri hareketini durdurduğunda özel bir fren ile durur.



Ünite, kalıpların konektörü ileriye doğru hızlı bir şekilde yaklaşması ve yavaş sıkma hareketi ile karakterize edilen çift pistonlu bir pompa ile donatılmıştır.



Kıvrıma kafası, sıkı gelenleri ve diğer zorlu çalışma alanlarına daha iyi erişim sağlamak için uzunlamasına ekseninde 360° döndürülebilir.



Li-ion bataryaların bellek etkisi ya da kendi kendine boşalması yoktur. Uzun süre çalıştırılmazsa bile alet her zaman çalışmaya hazırdır. Buna ek olarak, NiMH pillerle karşılaştırıldığında % 50 daha fazla kapasite ve şarjlı şarj döngüsü ile daha düşük bir güç ağırlık oranı görüyoruz.

ŞARJ EDİLEBİLİR PİLLİ PABUÇ SIKMA PENSELERİ (YATAY TİP)

ED-300 16-300 mm² PABUÇ SIKMA PENSESİ



Teknik Özellikler

Sıkma Kuvveti	: 60 Kn
Açılma Eni	: 17 mm
Sıkma Sayısı	: 320 (Cu 150mm ²)
Pilin Voltajı	: 18V
Pilin Kapasitesi	: 3,0Ah Li-Ion
Şarj Süresi	: 1 Saat

SET FİYATI 4.300,00-USD

Fiyata Dahil Aksesuarlar

1 TAKIM ÇENE (16-25-35-50-70-95-120-150-185-240-300)
1 AD ŞARJ EDİLEBİLİR PİL 18V 3,0 Ah
1 AD ŞARJ ALETİ
PLASTİK ÇANTA



Hidrolik ünite, maksimum çalışma basıncına ulaşıldığında pistonu başlangıç konumuna geri döndüren otomatik geri çekme mekanizmasına sahiptir



Elle geri çekme, yanlış kıvrılma durumunda pistonun başrol konumuna geri döndürülmesini sağlar. Ünite, tetik bırakıldığında piston ve kalıbın ileri hareketini durdurduğunda özel bir fren ile durur



Ünite, kalıpların konektörü ileriye doğru hızlı bir şekilde yaklaşması ve yavaş sıkma hareketi ile karakterize edilen çift pistonlu bir pompa ile donatılmıştır.



Kıvrıma kafası, sıkı gelenleri ve diğer zorlu çalışma alanlarına daha iyi erişim sağlamak için uzunlamasına eksenli etrafında düzgün bir şekilde 360 ° döndürülebilir.



Li-ion bataryaların bellek etkisi ya da kendi kendine boşalması yoktur. Uzun süre çalıştırılmazsa bile alet her zaman çalışmaya hazırdır. Buna ek olarak, NiMH pillerle karşılaştırıldığında %50 daha fazla kapasite ve şarjlı şarj döngüsü ile daha düşük bir güç ağırlık oranı görüyoruz.

ED-400 16-400 mm² PABUÇ SIKMA PENSESİ**Teknik Özellikler**

Sıkma Kuvveti	: 120 Kn
Açılma Eni	: 42 mm
Sıkma Sayısı	: 120 (Cu 150mm ²)
Pilin Voltajı	: 18V
Pilin Kapasitesi	: 3.0Ah Li-Ion
Şarj Süresi	: 1 Saat

SET FİYATI**4.800,00-USD****Fiyata Dahil Aksesuarlar**

1 TAKIM ÇENE (16-25-35-50-70-95-120-150-185-240-300-400)
1 AD ŞARJ EDİLEBİLİR PİL 18V 3,0 Ah
1 AD ŞARJ ALETİ
PLASTİK ÇANTA



Hidrolik ünite, maksimum çalışma basıncına ulaşıldığında pistonu başlangıç konumuna geri döndüren otomatik geri çekme mekanizmasına sahiptir



Elle geri çekme, yanlış kıvrılma durumunda pistonun başrol konumuna geri döndürülmesini sağlar. Ünite, tetik bırakıldığında piston ve kalıbın ileri hareketini durdurduğunda özel bir fren ile durur



Ünite, kalıpların konektörü ileriye doğru hızlı bir şekilde yaklaşması ve yavaş sıkma hareketi ile karakterize edilen çift pistonlu bir pompa ile donatılmıştır.



Kıvrırma kafası, sıkı gelenleri ve diğer zorlu çalışma alanlarına daha iyi erişim sağlamak için uzunlamasına eksenli etrafında düzgün bir şekilde 360 ° döndürülebilir.



Li-ion bataryaların bellek etkisi ya da kendi kendine boşalması yoktur. Uzun süre çalıştırılmazsa bile alet her zaman çalışmaya hazırdır. Buna ek olarak, NiMH pillerle karşılaştırıldığında %50 daha fazla kapasite ve şarjlı şarj döngüsü ile daha düşük bir güç ağırlık oranı görüyoruz.

MEKANİK KABLO KESME MAKASLARI (CİRCİRLİ TİP)

ZC-32A MEKANİK KABLO KESME MAKASI



ÜRÜN FİYATI
180,00-USD

Kesme Ölçüsü : Max. Ø 32mm Cu/Al kabloları
Ağırlık : 0.7 kg
Uzunluk : 360 mm

Çelik tel ve sert bakır tel kesmek için uygun değildir

ZC-36A MEKANİK KABLO KESME MAKASI



ÜRÜN FİYATI
185,00-USD

Kesme Ölçüsü : Max Ø 36mm Cu/Al kabloları
Ağırlık : 0.6 kg
Uzunluk : 260 mm

Çelik tel ve sert bakır tel kesmek için uygun değildir

ZC-60A MEKANİK KABLO KESME MAKASI



ÜRÜN FİYATI
285,00-USD

Kesme Ölçüsü : Max Ø 60mm Cu/Al kabloları
Ağırlık : 0.80 kg
Uzunluk : 320 mm

Çelik tel ve sert bakır tel kesmek için uygun değildir

TK-960 MEKANİK KABLO KESME MAKASI



ÜRÜN FİYATI
800,00-USD

Kesme Ölçüsü : Max.960mm² Cu/Al
Ağırlık : 4.4 kg
Uzunluk : 700 mm

Çelik tel ve sert bakır tel kesmek için uygun değildir

MEKANİK ÇELİK KESME MAKASLARI (ÇİRCİRLİ TİP)

ZCG-32A MEKANİK KABLO KESME MAKASI (Çelik Tel)

ÜRÜN FİYATI
550,00-USD

Kesme Ölçüsü	: Max.10mm ² Çelik Tel Max.600mm ² ACSR Max.Ø 32mm Cu/Al çekirdek kablo
Ağırlık	: 2.0 kg
Uzunluk	: 350 mm - 480 mm

ZCG-40 MEKANİK KABLO KESME MAKASI (Çelik Tel)

ÜRÜN FİYATI
660,00-USD

Kesme Ölçüsü	: Max. 20mm Çelik Tel Max. 36mm Cu/Al kablo
Ağırlık	: 3.6 kg
Uzunluk	: 440 mm - 630 mm

TC-250B MEKANİK KABLO KESME MAKASI (Çelik Tel)

ÜRÜN FİYATI
230,00-USD

Kesme Ölçüsü	: Max. 100 mm ² Cu/Al Max. 10 mm ² ÇELİK TEL Max. 7 mm ² DEMİR ÇUBUK
Ağırlık	: 2.4 kg
Uzunluk	: 600 mm

TC-500B MEKANİK KABLO KESME MAKASI (Çelik Tel)

ÜRÜN FİYATI
330,00-USD

Kesme Ölçüsü	: Max. 150 mm ² Cu/Al Max. 14 mm ² ÇELİK TEL Max. 9 mm ² DEMİR ÇUBUK
Ağırlık	: 2.9 kg
Uzunluk	: 710 mm

TCT-38 MEKANİK KABLO KESME MAKASI



Kesme Ölçüsü	: 400mm ² CU kabloları 500 mm ² AL kabloları Ayrıca 1 1/2" Telefon Kabloları (38 mm ²)
Ağırlık	: 2.8 kg
Uzunluk	: 800 mm

Çelik tel ve sert bakır tel kesmek için uygun değildir

ÜRÜN FİYATI
200,00-USD

MEKANİK KABLO KESME MAKASLARI



TC-100 MEKANİK KABLO KESME MAKASI

Kesme Ölçüsü : 120 mm² Cu/Al kabloları
Ağırlık : 0.7 kg
Uzunluk : 320 mm

Çelik tel ve sert bakır tel kesmek için uygun değildir

ÜRÜN FİYATI
65,00-USD



TC-125S MEKANİK KABLO KESME MAKASI

Kesme Ölçüsü : 120 mm² Cu/Al kabloları
Ağırlık : 1.25 kg
Uzunluk : 300 mm-400 mm (Teleskopik kollar sayesinde uzatılabilir)

Çelik tel ve sert bakır tel kesmek için uygun değildir

ÜRÜN FİYATI
150,00-USD



TC-250S MEKANİK KABLO KESME MAKASI

Kesme Ölçüsü : 240 mm² Cu/Al kabloları
Ağırlık : 2.28 kg
Uzunluk : 415 mm - 565 mm (Teleskopik kollar sayesinde uzatılabilir)

Çelik tel ve sert bakır tel kesmek için uygun değildir

ÜRÜN FİYATI
170,00-USD



TC-250A MEKANİK KABLO KESME MAKASI

Kesme Ölçüsü : 240 mm² Cu/Al kabloları
Ağırlık : 2.3 kg
Uzunluk : 600 mm

Çelik tel ve sert bakır tel kesmek için uygun değildir

ÜRÜN FİYATI
170,00-USD



TC-500A MEKANİK KABLO KESME MAKASI

Kesme Ölçüsü : 500mm² Cu/Al kabloları
Ağırlık : 2.8 kg
Uzunluk : 710 mm

Çelik tel ve sert bakır tel kesmek için uygun değildir

ÜRÜN FİYATI
260,00-USD

HİDROLİK KABLO KESME MAKASLARI**CPC-40A HİDROLİK KABLO KESME MAKASI**

Kesme Kuvveti	: 60KN
Kesme Ölçüsü	: Ø32 mm Cu/Al Zırlı kablo Ø40 mm Telefon Kablosu
Yükseklik	: 570 mm
Ağırlık	: 5.2 kg

ÜRÜN FİYATI
420,00-USD

CPC-40BL HİDROLİK KABLO KESME MAKASI

Kesme Kuvveti	: 60KN
Kesme Ölçüsü	: Max 40mm ACSR Max 28mm Çelik Tel
Yükseklik	: 600 mm
Ağırlık	: 5.6 kg

ÜRÜN FİYATI
850,00-USD

HZ-65C HİDROLİK KABLO KESME MAKASI

Kesme Kuvveti	: 60KN
Kesme Ölçüsü	: 45 mm Cu/Al Zırlı Kablolar 65 mm Cu/Al Kablolar
Ağırlık	: 5.5 kg

ÜRÜN FİYATI
1.500,00-USD

HZ-45 HİDROLİK KABLO KESME MAKASI

Kesme Kuvveti	: 60KN
Kesme Ölçüsü	: Ø45mm Cu/Al ve Ø45mm Cu/Al Zırlı kablo
Açılma Eni	: 50 mm
Yükseklik	: 560 mm
Ağırlık	: 4.8 kg

ÜRÜN FİYATI
1.200,00-USD

HZ-85 HİDROLİK KABLO KESME MAKASI

Kesme Kuvveti	: 60KN
Kesme Ölçüsü	: 85mm Cu/Al ve 45mm Cu/Al Zırlı kablo
Açılma Eni	: 50 mm
Ağırlık	: 7.6 kg

ÜRÜN FİYATI
1.700,00-USD

CPC-50A HİDROLİK KABLO KESME MAKASI

Kesme Kuvveti	: 60KN
Kesme Ölçüsü	: Ø45mm Cu/Al Zırlı kablo Ø50mm Telefon Kablosu
Yükseklik	: 630 mm
Ağırlık	: 7.1 kg

ÜRÜN FİYATI
490,00-USD

CPC-22A HİDROLİK DEMİR KESME MAKASI

Kesme Kuvveti	: Ø 4 mm - Ø 22 mm
Yükseklik	: 340 mm
Ağırlık	: 4.2 kg

ÜRÜN FİYATI
210,00-USD

HİDROLİK KABLO KESME BAŞLIKLARI



CPC-65C HİDROLİK KABLO KESME BAŞLIĞI

ÜRÜN FİYATI
740,00-USD

Kesme Kuvveti : 60KN
Kesme Ölçüsü : 45 mm Cu/Al Zırlı Kablolar
65 mm Cu/Al Kablolar
Ağırlık : 6.2kg

CPC-85C HİDROLİK KABLO KESME BAŞLIĞI

ÜRÜN FİYATI
900,00-USD

Kesme Kuvveti : 60KN
Kesme Ölçüsü : 65 mm Cu/Al Zırlı kablo
85 mm Cu/Al Kablolar
Ağırlık : 6.7 kg



CC-50B HİDROLİK KABLO KESME BAŞLIĞI

ÜRÜN FİYATI
550,00-USD

Kesme Kuvveti : 60KN
Kesme Ölçüsü : 45mm Cu/Al Zırlı kablo
50mm Telefon Kablosu
Yükseklik : 340 mm
Ağırlık : 6.2 kg



CPC-40B HİDROLİK KABLO KESME BAŞLIĞI

ÜRÜN FİYATI
700,00-USD

Kesme Kuvveti : 60KN
Kesme Ölçüsü : Max 40mm ACSR
Max 28mm Çelik Tel
Yükseklik : 320 mm
Ağırlık : 3.8 kg



CPC-85B HİDROLİK KABLO KESME BAŞLIĞI

ÜRÜN FİYATI
820,00-USD

Kesme Kuvveti : 60KN
Kesme Ölçüsü : 50mm Cu/Al Zırlı kablo
85mm Telefon Kablosu
Yükseklik : 465 mm
Ağırlık : 7.9 kg



CPC-100B HİDROLİK KABLO KESME BAŞLIĞI

ÜRÜN FİYATI
1.000,00-USD

Kesme Kuvveti : 60KN
Kesme Ölçüsü : 75mm Cu/Al Zırlı kablo
100mm Telefon Kablosu
Yükseklik : 515 mm
Ağırlık : 8.4 kg

***Bu ekipmanlar Sayfa 70' deki ürünler ile entegre çalışır.**

ŞARJ EDİLEBİLİR PİLLİ KABLO KESME YENGEÇ KAFA MAKASLARI

EB-85 C KABLO KESME MAKASI

**SET FİYATI**
5.000,00-USD**Fiyata Dahil Aksesuarlar**

1 AD ŞARJ EDİLEBİLİR PİL 18V 3,0 Ah

1 AD ŞARJ CİHAZI

PLASTİK ÇANTA

1 TAKIM KESME ÇENESİ

Teknik Özellikler**Kesme Kuvveti** : 60 Kn**Açılma Eni** : 85 mm**Kullanılan Kablo Tipi** : 65 mm Zırlı Cu/Al kablo

: 85 mm Cu/Al kablo

Pilin Voltajı : 18V**Pilin Kapasitesi** : 3.0Ah Li-Ion**Şarj Süresi** : 1 Saat

EB-105 C KABLO KESME MAKASI

**SET FİYATI**
5.150,00-USD**Fiyata Dahil Aksesuarlar**

1 AD ŞARJ EDİLEBİLİR PİL 18V 3,0 Ah

1 AD ŞARJ CİHAZI

PLASTİK ÇANTA

1 TAKIM KESME ÇENESİ

Teknik Özellikler**Kesme Kuvveti** : 120 Kn**Açılma Eni** : 105 mm**Kullanılan Kablo Tipi** : 85 mm Zırlı Cu/Al kablo

: 105 mm Cu/Al kablo

Pilin Voltajı : 18V**Pilin Kapasitesi** : 3.0Ah Li-Ion**Şarj Süresi** : 1 Saat

ŞARJ EDİLEBİLİR PİLLİ KABLO KESME MAKASLARI

ED-45 KABLO KESME MAKASI



SET FİYATI 3.800,00-USD

Fiyata Dahil Aksesuarlar
1 AD ŞARJ EDİLEBİLİR PİL 18V 3,0 Ah
1 AD ŞARJ CİHAZI
PLASTİK ÇANTA
1 TAKIM KESME ÇENESİ

Teknik Özellikler

Kesme Kuvveti	: 60 Kn
Açılma Eni	: 50 mm
Kullanılan Kablo Tipi	: 45 mm Cu/Al ve Zırlı kablo
Pilin Voltajı	: 18V
Pilin Kapasitesi	: 3.0Ah Li-Ion
Şarj Süresi	: 1 Saat

ED-85 KABLO KESME MAKASI



SET FİYATI 4.100,00-USD

Fiyata Dahil Aksesuarlar
1 AD ŞARJ EDİLEBİLİR PİL 18V 3,0 Ah
1 AD ŞARJ CİHAZI
PLASTİK ÇANTA
1 TAKIM KESME ÇENESİ

Teknik Özellikler

Kesme Kuvveti	: 60 Kn
Açılma Eni	: 50 mm
Kullanılan Kablo Tipi	: 85 mm Cu/Al ve Zırlı kablo
Pilin Voltajı	: 18V
Pilin Kapasitesi	: 3.0Ah Li-Ion
Şarj Süresi	: 1 Saat

HİDROLİK POMPALAR

CP-700 HİDROLİK EL POMPASI



Maksimum Çıkış Basıncı	
Alçak Basınc	: 20 Bar
Yüksek Basınc	: 700 Bar
Yağ Çıkışı	
Alçak Basınc	: 13 cc
Yüksek Basınc	: 2,3 cc

Yağ Kapasitesi	: 900 cc
Piston Yönü	: ÇİFT
Ağırlık	: 9 kg
Ölçü	: 510x140x150mm

ÜRÜN FİYATI
600,00-USD

TFP-800 HİDROLİK AYAK POMPASI



Maksimum Çıkış Basıncı	
Alçak Basınc	: 20 Bar
Yüksek Basınc	: 700 Bar
Yağ Çıkışı	
Alçak Basınc	: 13 cc
Yüksek Basınc	: 2,3 cc

Yağ Kapasitesi	: 850 cc
Piston Yönü	: ÇİFT
Ağırlık	: 11 kg
Ölçü	: 450x150x200mm

ÜRÜN FİYATI
750,00-USD

EB-700 PİL İLE ÇALIŞAN TAŞINABİLİR POMPA



Yağ Kapasitesi	: 700 ml
Basınc	: 700 Bar
Güç	: 490W
Pilin Voltajı	: 18V
Pilin Kapasitesi	: 5.0Ah Li-Ion
Ağırlık	: 5.9 Kg.

Fiyata Dahil Aksesuarlar
1 AD ŞARJ EDİLEBİLİR PİL 18V 5,0 Ah
1 AD ŞARJ CİHAZI
1 AD TAŞIMA APARATI

ÜRÜN FİYATI
4,400,00-USD



ŞARJ EDİLEBİLİR PİLLİ YÜKSÜK SIKMA PENSESİ



TEW-50X



ÜRÜN FİYATI 2.000,00-USD

ŞARJ EDİLEBİLİR PİLLİ YÜKSÜK SİMA PENSESİ

Ağırlık 1,55

Kutu Ölçü 277x22x61 mm

Kullanım Alanı

İzoleli Yüksük Ø 0,50-50 mm² İzoleli Yüksükler

Kaynaklı Tip Ø 0,5-10 mm² Kaynaklı tip pabuçlar

Yuvarlak Tip Ø 0,6-6 mm² Yuvarlak tip

Sıkma Kuvveti : 16 Kn

Pilin Voltajı : 18V

Pilin Kapasitesi : 2.0Ah Li-Ion

Şarj Süresi : 1 Saat

MEKANİK EL ALETLERİ

YÜKSÜK SIKMA PENSELERİ

PZ 0.25-2.5



ÜRÜN FİYATI

25,00-USD

Sıkma Ölçüsü

0,25 mm² - 2.5 mm²

Ağırlık

0,2

Uzunluk

135 mm

Sıkma Profili



PZ 0.5-16



ÜRÜN FİYATI

30,00-USD

Sıkma Ölçüsü

0,5 mm² - 16 mm²

Ağırlık

0,31

Uzunluk

220 mm

Sıkma Profili



ANO-4WFL (YAC-5)



ÜRÜN FİYATI

57,00-USD

Sıkma Ölçüsü

0,5 mm² - 6 mm²

Ağırlık

0,6

Uzunluk

230 mm

Sıkma Profili



AN-16WF (YAC-6)



ÜRÜN FİYATI

57,00-USD

Sıkma Ölçüsü

6 mm² - 16 mm²

Ağırlık

0,6

Uzunluk

230 mm

Sıkma Profili



AN-35WF (YAC-35)



ÜRÜN FİYATI

60,00-USD

Sıkma Ölçüsü

10 mm² - 35 mm²

Ağırlık

0,6

Uzunluk

235 mm

Sıkma Profili



AN-50WF (YAC-50)



ÜRÜN FİYATI

60,00-USD

Sıkma Ölçüsü

25 mm² - 50 mm²

Ağırlık

0,6

Uzunluk

235 mm

Sıkma Profili



MEKANİK EL ALETLERİ

YÜKSÜK SIKMA PENSELERİ

HSC8 6-4A (YAC-8)



Sıkma Profili



HSC8 6-6A

Sıkma Profili

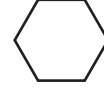
**ÜRÜN FİYATI 78,00-USD**Sıkma Ölçüsü 0,25 mm² - 6 mm²

Ağırlık 0,39

Uzunluk 175 mm

ÜRÜN FİYATI 88,00-USDSıkma Ölçüsü 0,25 mm² - 6 mm²

Ağırlık 0,39

Uzunluk 175 mm

ZSY 16-4

**ÜRÜN FİYATI 88,00-USD**Sıkma Ölçüsü 0,8 mm² - 16 mm²

Ağırlık 0,4

Uzunluk 180 mm

Sıkma Profili



TERMİNAL SIKMA PENSELERİ

AN-03C (YYT-1)

**ÜRÜN FİYATI 48,00-USD**Sıkma Ölçüsü 0,5-6 mm² İzoleli terminaller

Ağırlık 0,6

Uzunluk 230 mm

Sıkma Profili



AN-006 (YYT-7)

**ÜRÜN FİYATI 55,00-USD**Sıkma Ölçüsü 0,5-6 mm² İzoleli terminaller

Ağırlık 0,6

Uzunluk 230 mm

Sıkma Profili



AN-03B (YYT-11)

**ÜRÜN FİYATI 55,00-USD**Sıkma Ölçüsü 0,5-6 mm² İzolesiz terminaller

Ağırlık 0,6

Uzunluk 230 mm

Sıkma Profili



AN-004 (YYT-8)

**ÜRÜN FİYATI 55,00-USD**Sıkma Ölçüsü 0,5-10 mm² Kaynaklı tip pabuçlar

Ağırlık 0,6

Uzunluk 230 mm

Sıkma Profili



KONNEKTÖR SIKMA PENSESİ

HT-86



ÜRÜN FİYATI 45,00-USD

Sıkma Ölçüsü RJ 11/12 (6 P) - FJ 45 (8 P)

Ağırlık 0,28

Uzunluk 190 mm

KABLO BAĞI SIKMA PENSELERİ

TG-008



ÜRÜN FİYATI 50,00-USD

Sıyırma Aralığı Ø 2,2 mm - Ø 4,8 mm

Naylon kablo bağlarını sıkmak için kullanılır

ÇELİK KABLO BAĞI SIKMA PENSELERİ

TG-328



ÜRÜN FİYATI 240,00-USD

Sıyırma Aralığı Ø 4,8 mm - Ø 7,5 mm

Çelik kablo bağlarını sıkmak için kullanılır

TG-11



ÜRÜN FİYATI 150,00-USD

Sıkma Aralığı Ø 4,6 - 12 mm

Çelik kablo bağlarını sıkmak için kullanılır

MEKANİK EL ALETLERİ

MLT-3SET (T007)



ÜRÜN FİYATI 130,00-USD

Sıkma Ölçüsü

0,5-6 mm² İzoleli Kablo Yüksükleri
0,5-10 mm² Kaynaklı tip pabuçlar
0,5-10 mm² İzolesiz kablo uçları için

Ağırlık

0,61

Uzunluk

220 mm



TO-035DC-ST



SET İÇERİĞİ

AN-10

1,5-10 mm² Kaynaklı tip pabuçlar

Sıkma profili



AN-03B

0,5-6 mm² İzolesiz terminaller

Sıkma profili



AN-04WF

1-6 mm² İzoleli Yüksükler

Sıkma profili



AN-16WF

6-16 mm² İzoleli Yüksükler

Sıkma profili



AN-03C

0,5-6 mm² İzolesiz terminaller

Sıkma profili



ÜRÜN FİYATI 140,00-USD

MULTİFONKSİYONEL KABLO UCU SIKMA

Ağırlık

1,55

Kutu Ölçü

277x222x61 mm

T-16



ÜRÜN FİYATI 72,00-USD

Sıkma Ölçüsü

1,5-16 mm² SKP Sıkma Pensesi

Ağırlık

0,7

Uzunluk

250 mm

Sıkma Profili



HD-50L



ÜRÜN FİYATI 85,00-USD

Sıkma Ölçüsü

6-50 mm² SKP Sıkma Pensesi

Ağırlık

0,7

Uzunluk

325 mm

Sıkma Profili



MEKANİK EL ALETLERİ KABLO SIYIRMA PENSELERİ



YY-78318

ÜRÜN FİYATI 28,00-USD

Sıyırma Aralığı 0,2-6 mm² (Kablo kesme makası mevcuttur)

Ağırlık 0,2 kg

Uzunluk 175 mm

BXQ-Z40B

ÜRÜN FİYATI 330,00-USD

Sıyırma Aralığı Ø 14mm - Ø 40 mm çapındaki kablolar

Ağırlık 0,9 kg

Uzunluk 275 x 95 x 60



SK-30

ÜRÜN FİYATI 135,00-USD

Sıyırma Aralığı Ø 13 mm - Ø 30 mm

Ağırlık 0,8 kg

Uzunluk 325 mm



SK-40

ÜRÜN FİYATI 400,00-USD

Sıyırma Aralığı Ø 20 mm - Ø 40 mm

Ağırlık 0,8 kg

Uzunluk 250 mm

4-28 H



Sıyırma Aralığı : Ø 4 - 28 mm

Uzunluk : 185 mm / **Ağırlık**: 98 gr

Fiyat : **28 EURO**

Açıklama : 4 - 28 mm çapındaki tüm sıradan yuvarlak kablolar için.

Kablo Tipi : İnce telli ve PVC izoleli katı iletkenler.

İç Bıçak : Ayarlanabilir + Değiştirilebilir.



www.torkelektroteknik.com

 WhatsApp Destek
0530 969 63 90

KABLO YÜKSÜKLERİ
ISI MAKARONLARI
KABLO BAĞI
POTANSİYOMETRE
MUFLLAR
TERMINALLER
BUTONLAR
KABLO UÇLARI

SKP



Kablo bağı bizim işimiz....

TORK ELEKTROTEKNİK SAN. ve TİC. LTD. ŞTİ.

Merkez : Esenkent Mahallesi, Methiye Sk. No:3

Dudullu Osb - Ümraniye / İstanbul / Türkiye

Tel: +90 216 471 35 35 Fax: +90 216 471 35 34

Şube: Okçu Musa Cad. Menevşe Han No:22 Kat:1 D:129 Karaköy - İstanbul

tork@torkelektroteknik.com